

ARCHITECTURAL

MISCELLANEOUS

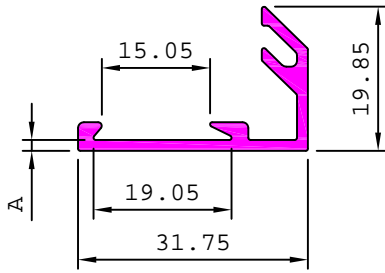

SL. No.	Section No.	A	Weight kg/m
1	22856	0.80	0.165
2	22858	1.08	0.219
3	22857	1.50	0.287
4	22851	2.00	0.339

22852

1.379 kg/m

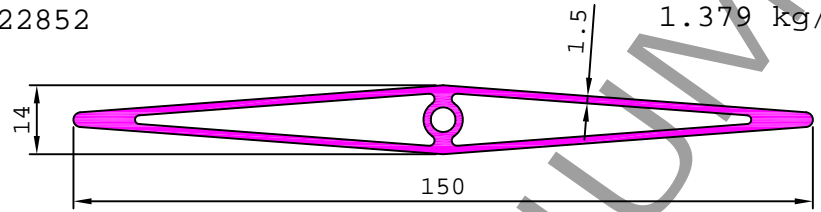

22867

0.655 kg/m

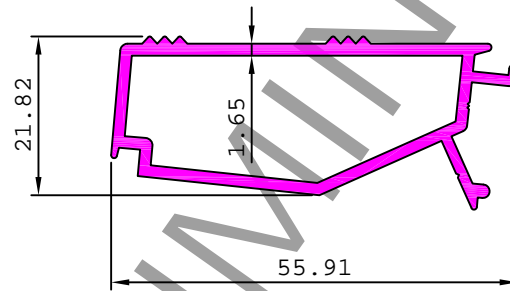

22869

0.574 kg/m

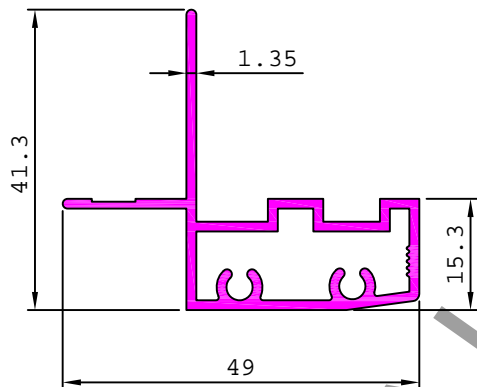

22874

1.085 kg/m

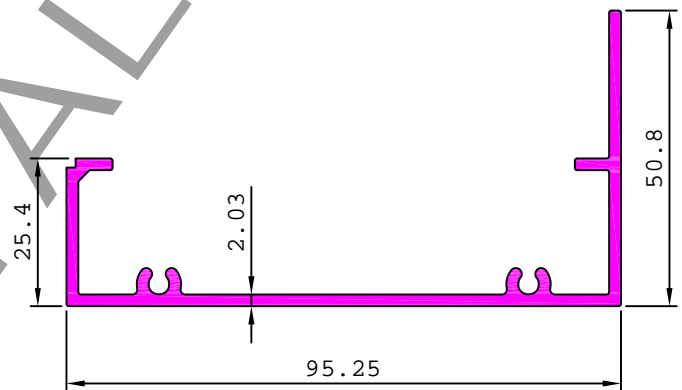

22866

1.020 kg/m

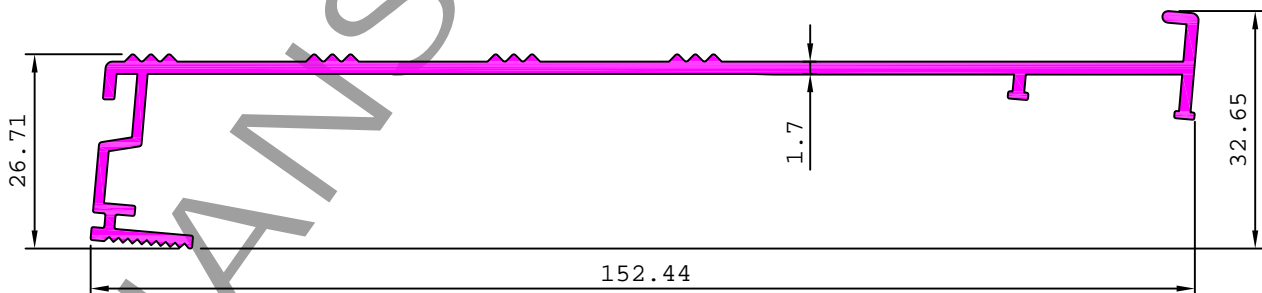

22873

0.983 kg/m

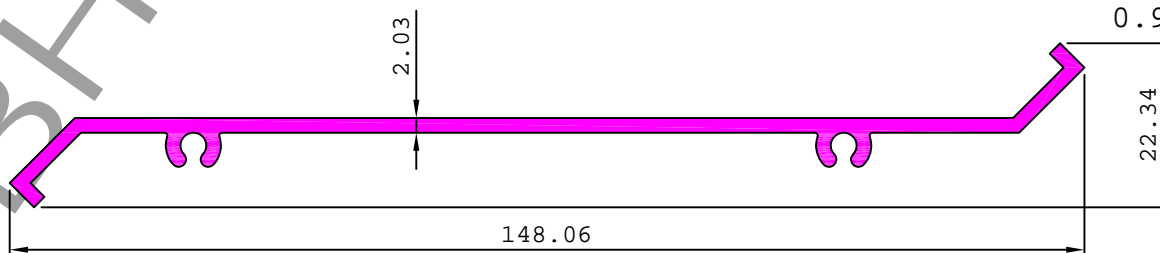

ARCHITECTURAL

MISCELLANEOUS

22875

1.168 kg/m

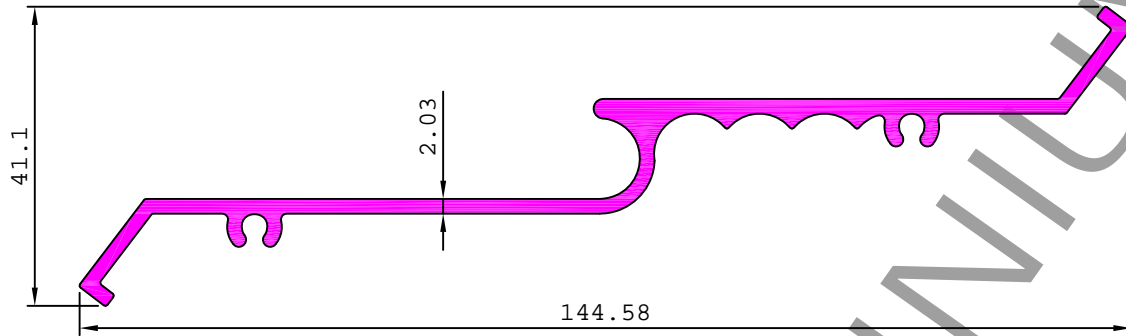

22876

0.659 kg/m

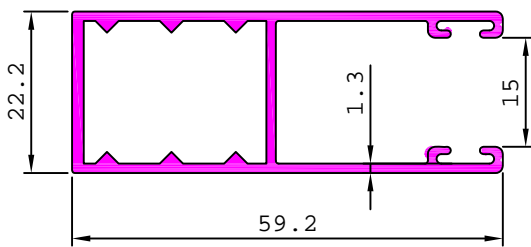

22877

0.481 kg/m

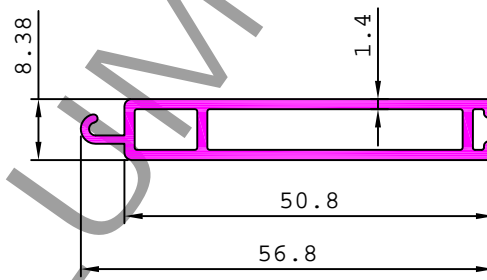

22882

0.387 kg/m

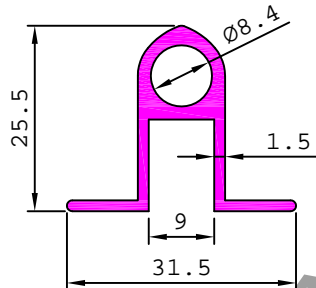

22884

0.268 kg/m

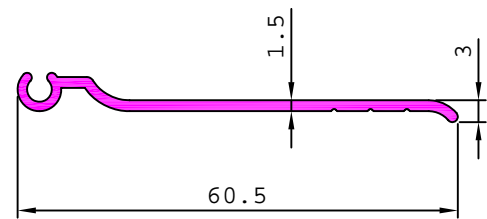

22885

2.100 kg/m

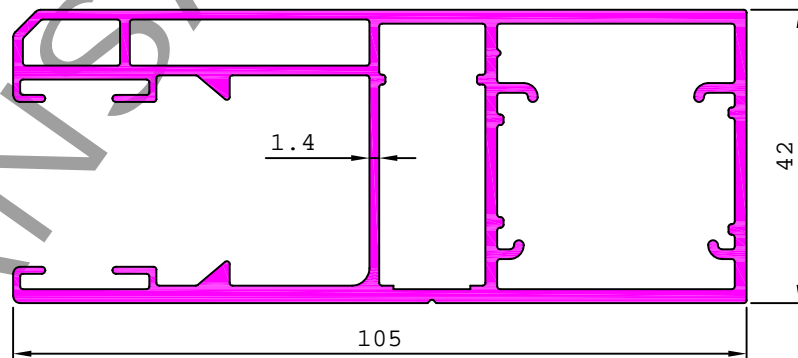

22886

0.887 kg/m

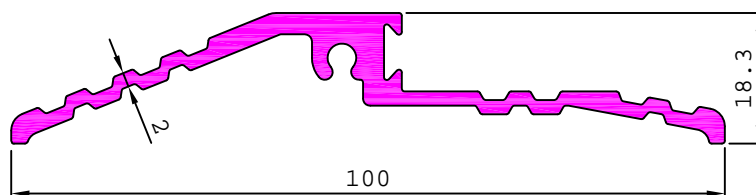

ARCHITECTURAL

MISCELLANEOUS

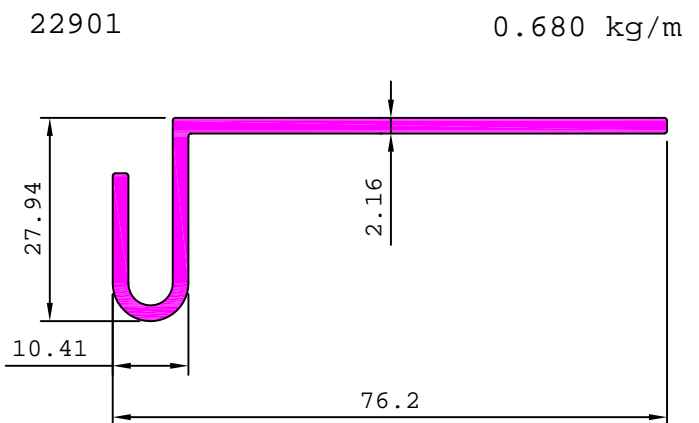
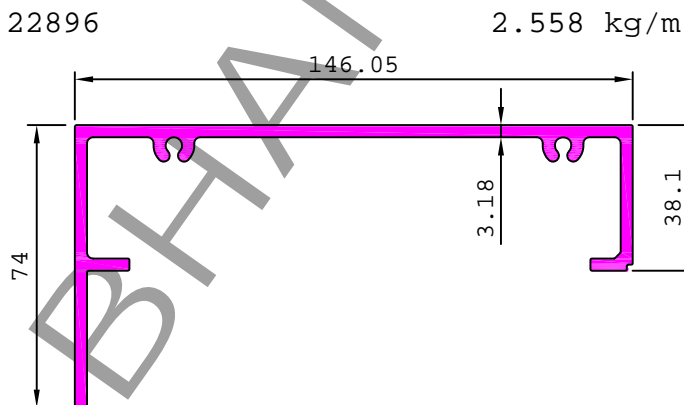
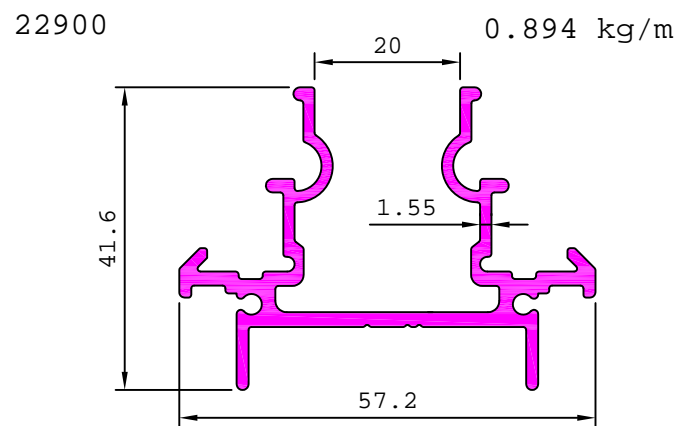
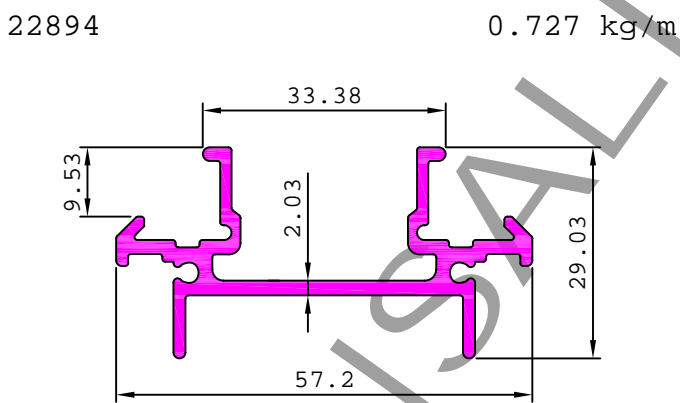
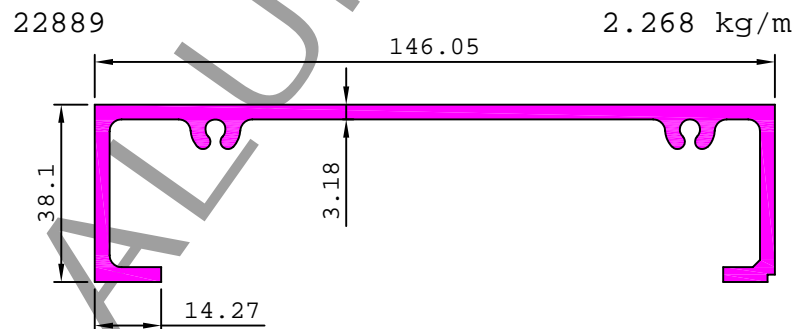
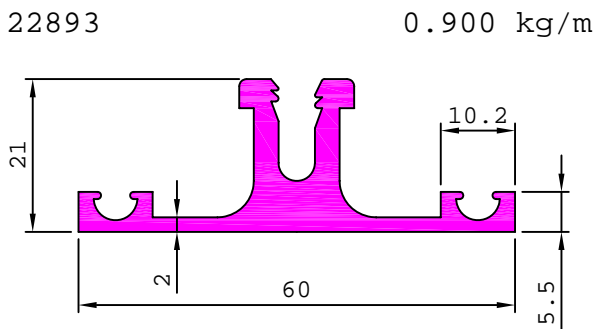
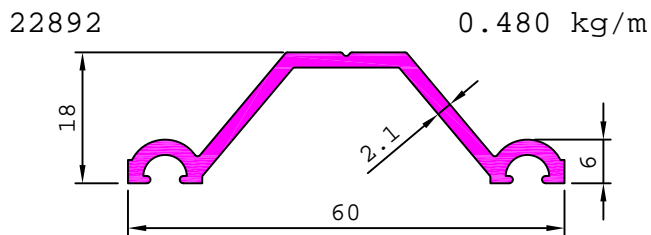
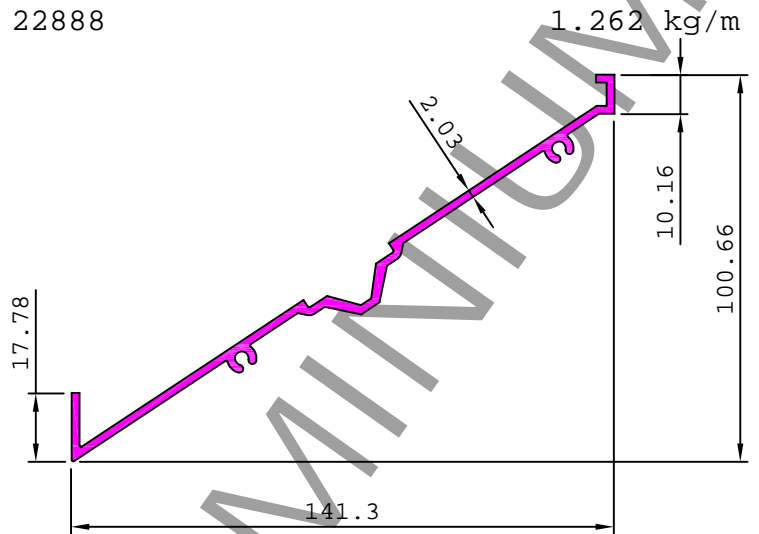
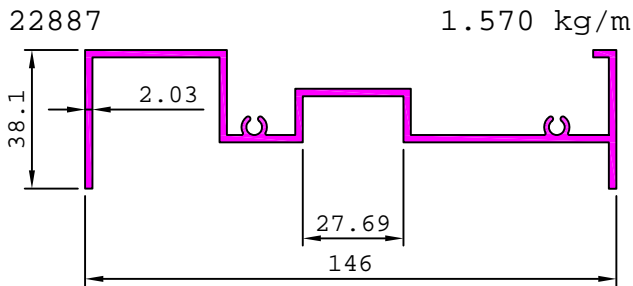

ARCHITECTURAL

MISCELLANEOUS

22897

2.216 kg/m

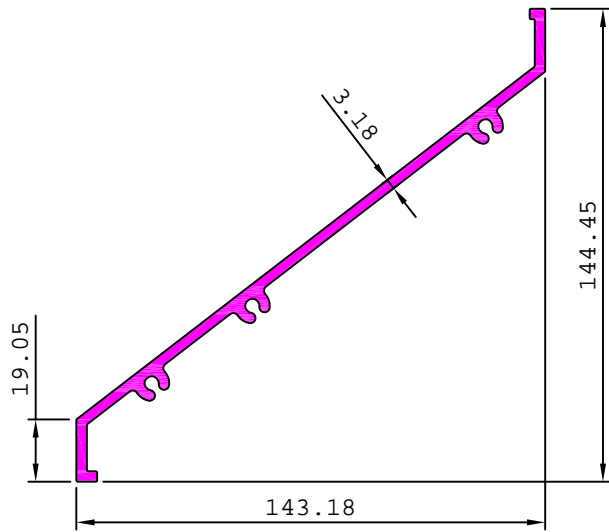

22898

1.525 kg/m

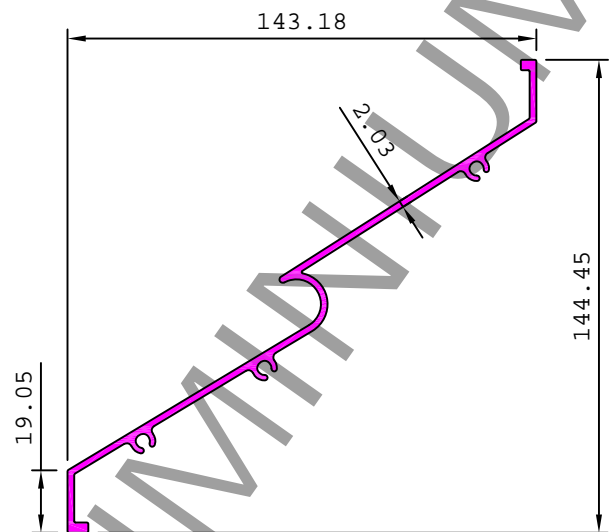

22902

6.689 kg/m

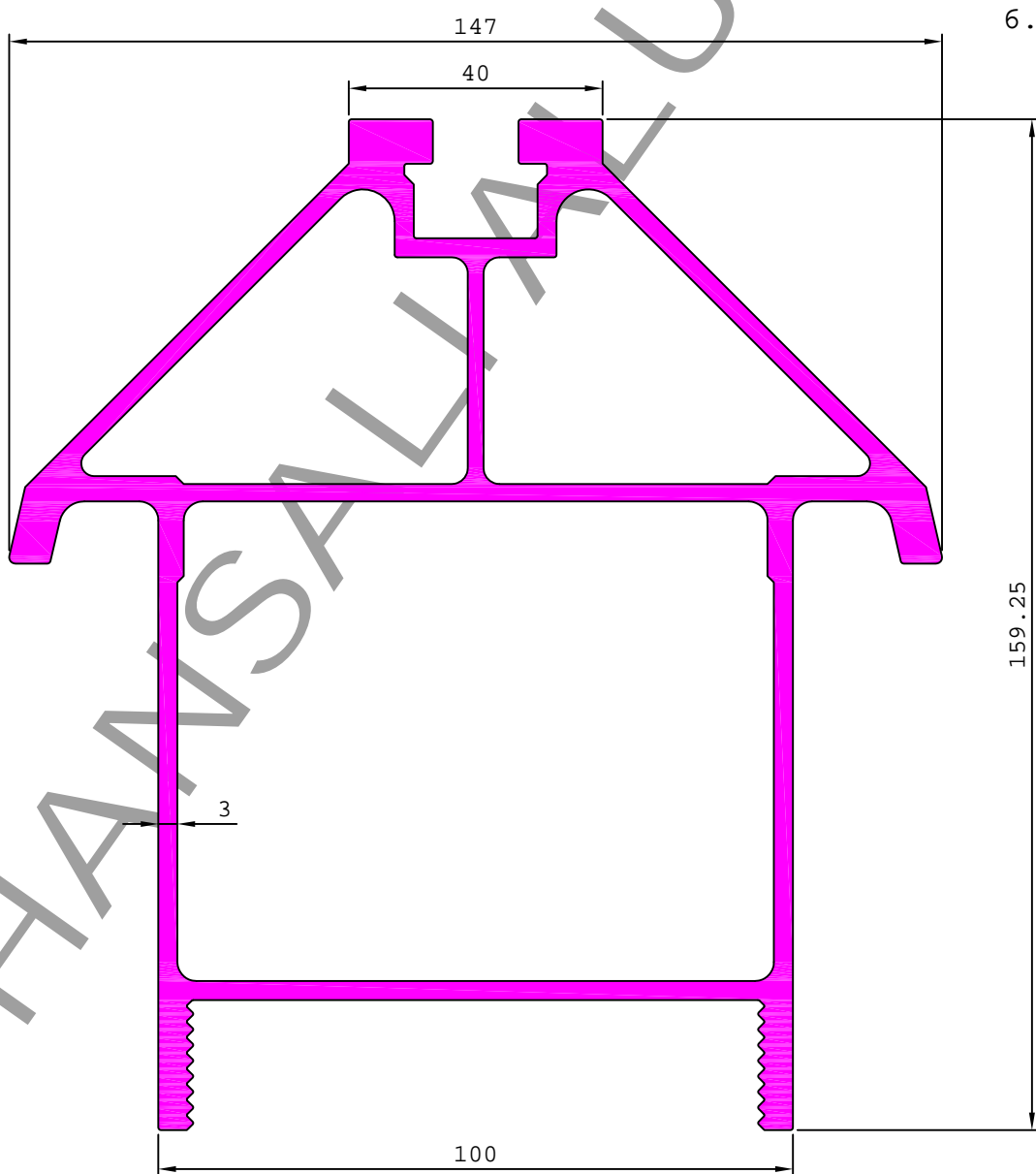

ARCHITECTURAL

MISCELLANEOUS

22905 0.413 kg/m

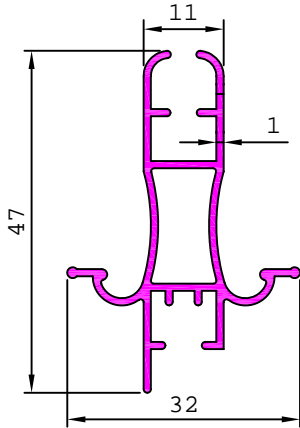

22910 1.137 kg/m

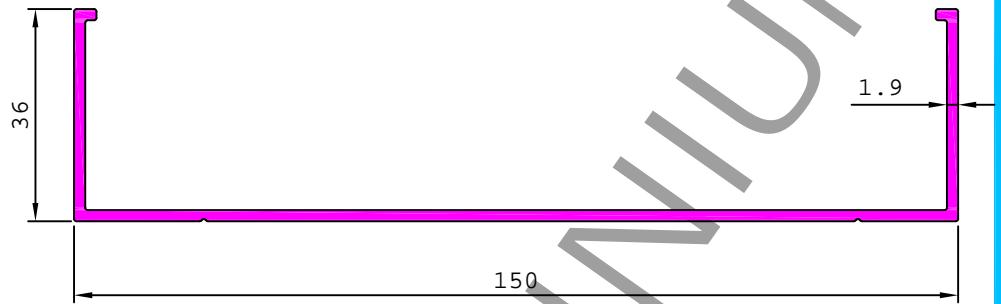

22908 0.485 kg/m

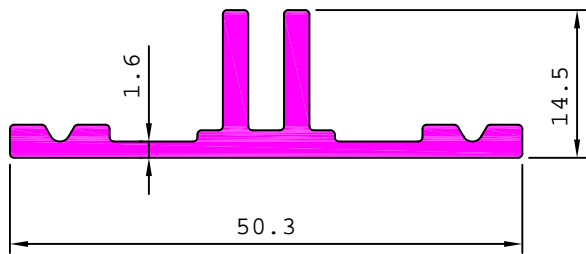

22909 0.326 kg/m

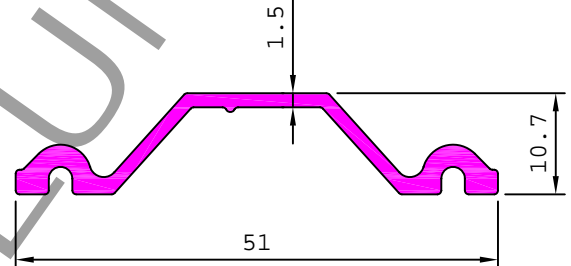

22911 2.805 kg/m

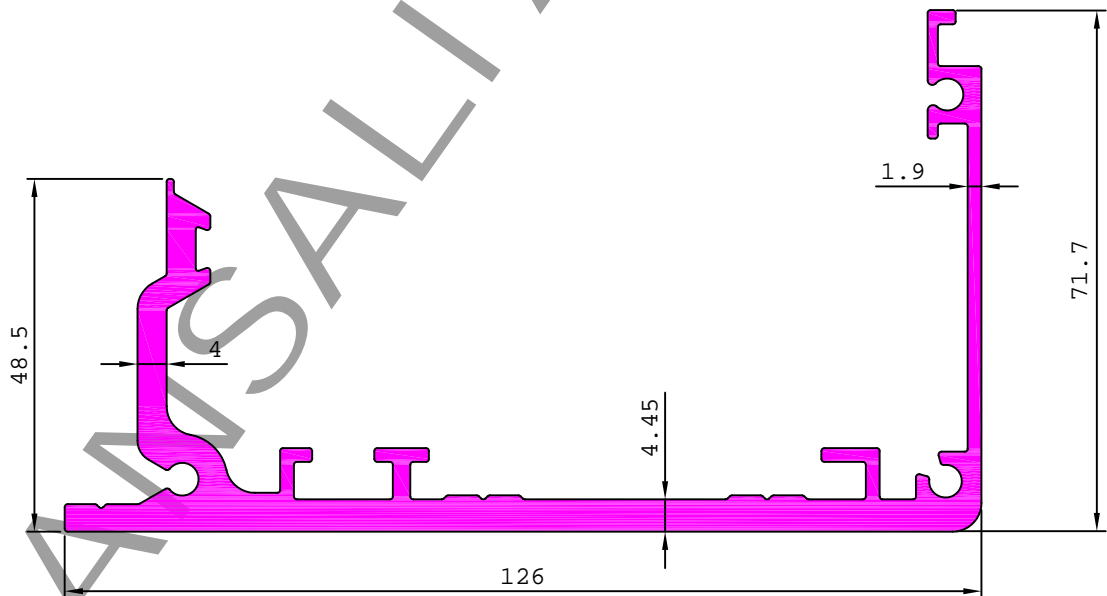

22919 2.966 kg/m

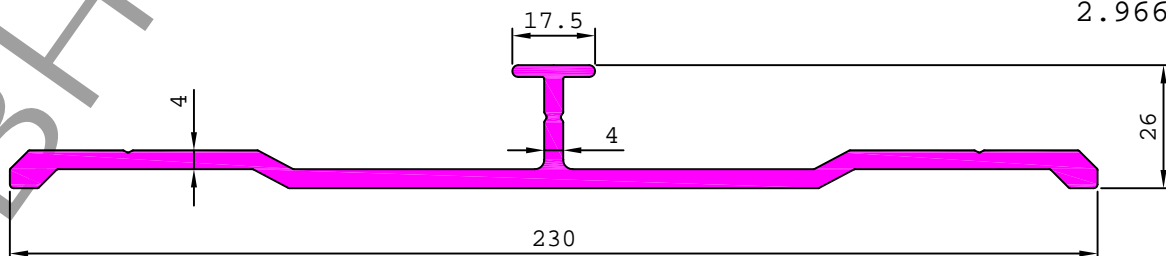

ARCHITECTURAL

MISCELLANEOUS

22912

2.504 kg/m

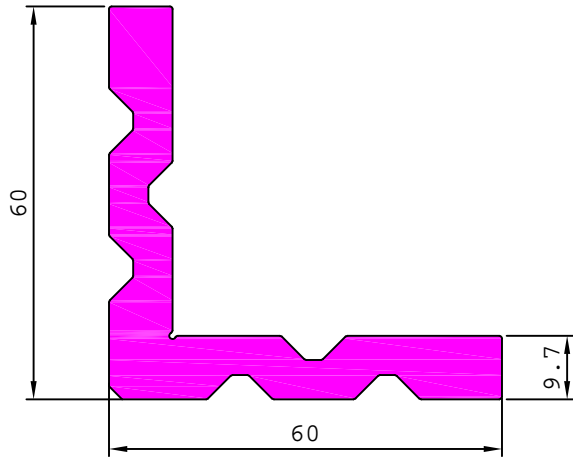

22915

0.579 kg/m

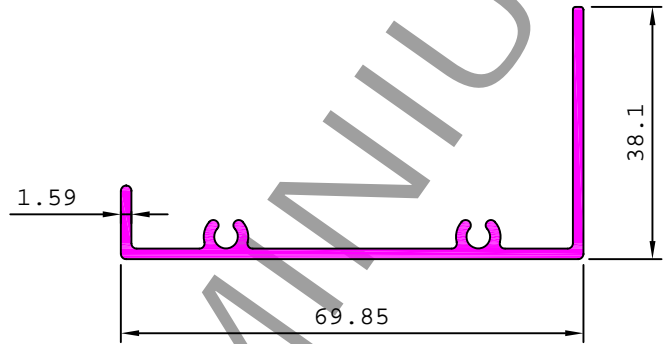

22913

2.334 kg/m

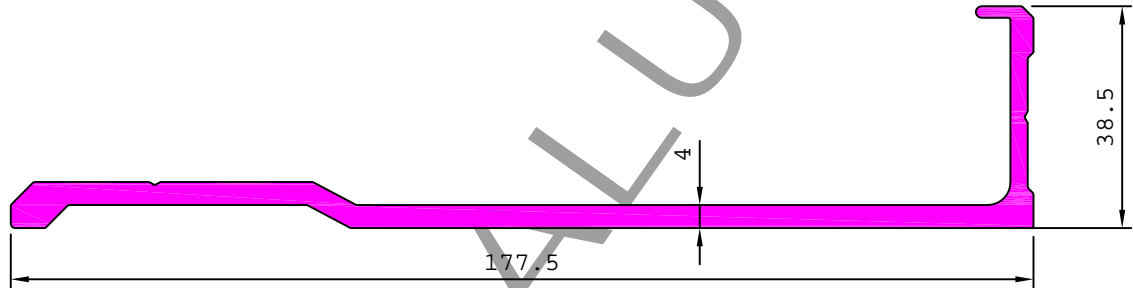

22916

0.808 kg/m

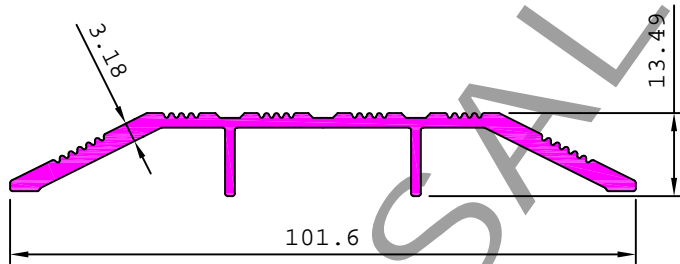

22917

5.569 kg/m

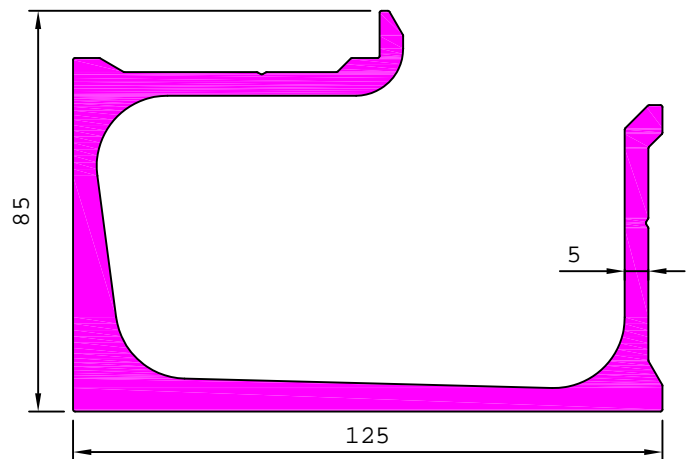

22918

5.357 kg/m

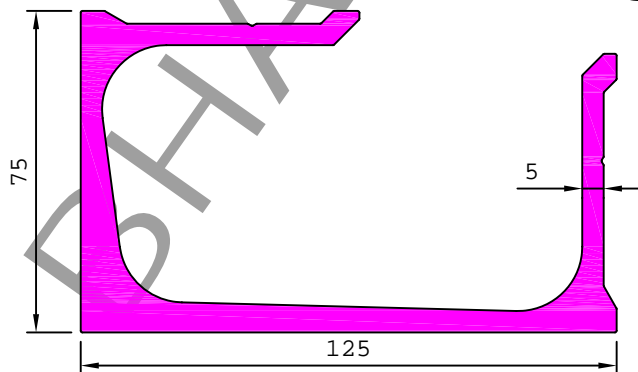

22920

1.369 kg/m

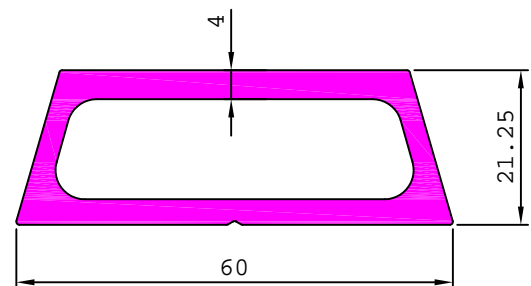

ARCHITECTURAL

MISCELLANEOUS

22921 0.971 kg/m

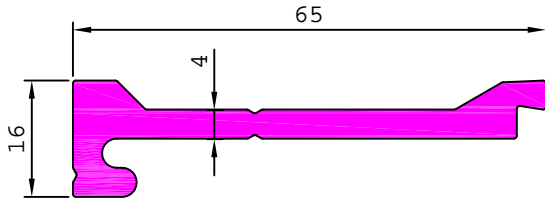

22922 0.555 kg/m

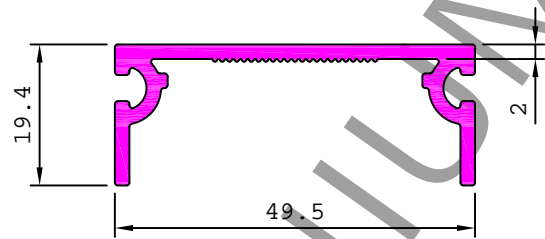

22923 0.724 kg/m

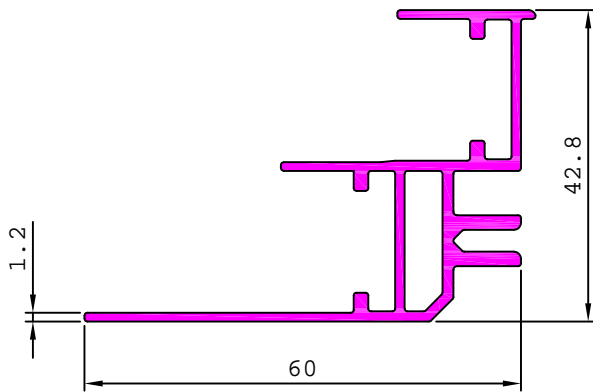

22926 1.493 kg/m

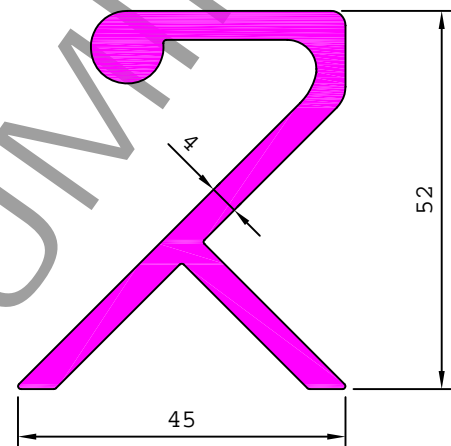

22924 2.277 kg/m

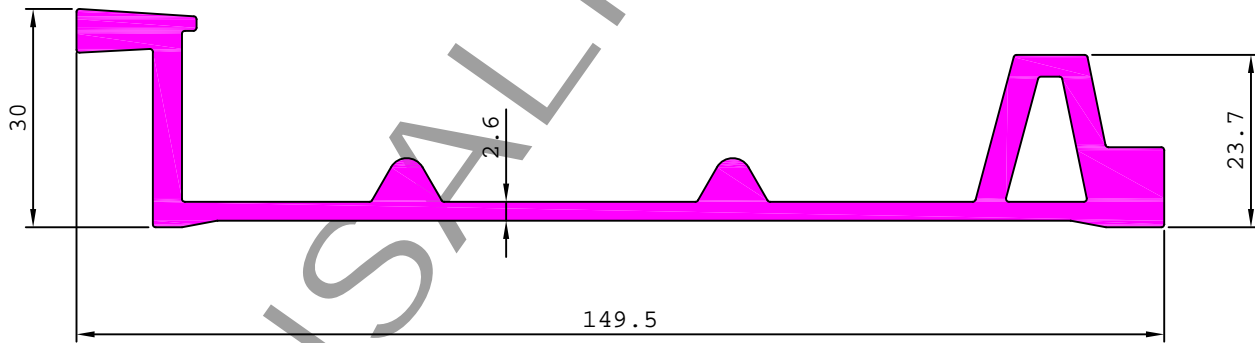

22925 2.510 kg/m

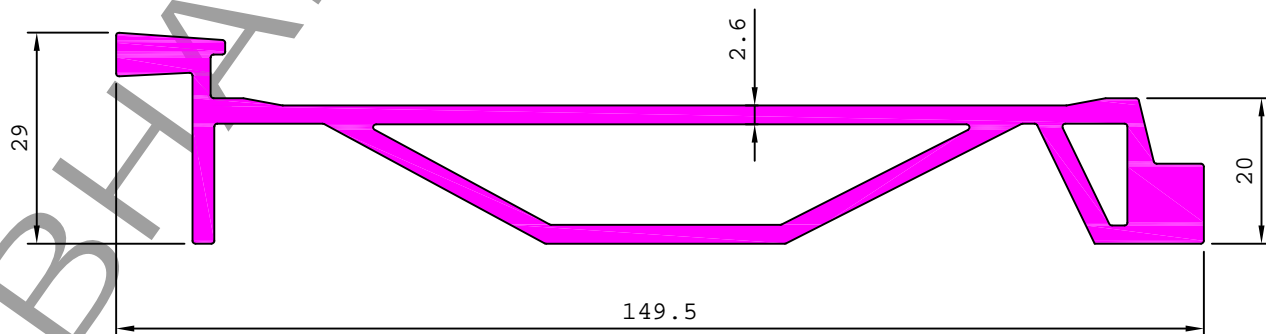

ARCHITECTURAL

MISCELLANEOUS

22927

1.929 kg/m

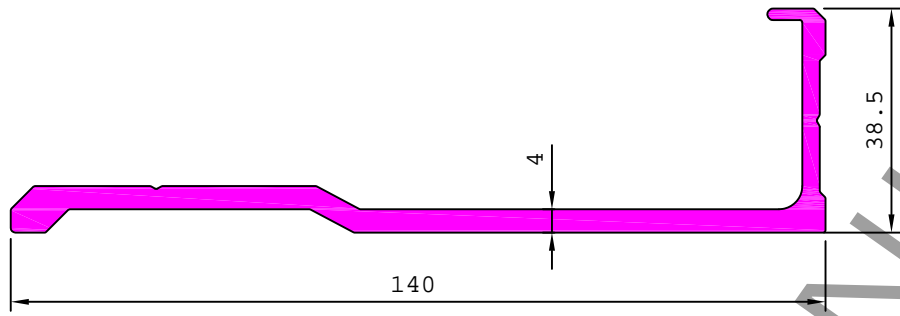

22928

2.199 kg/m

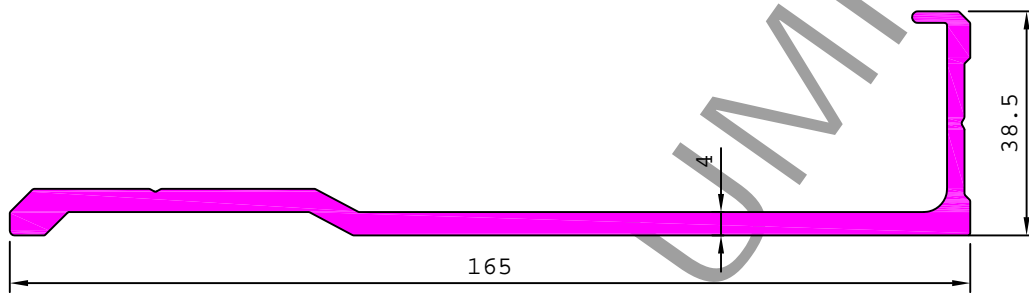

22929

1.203 kg/m

22930

1.233 kg/m

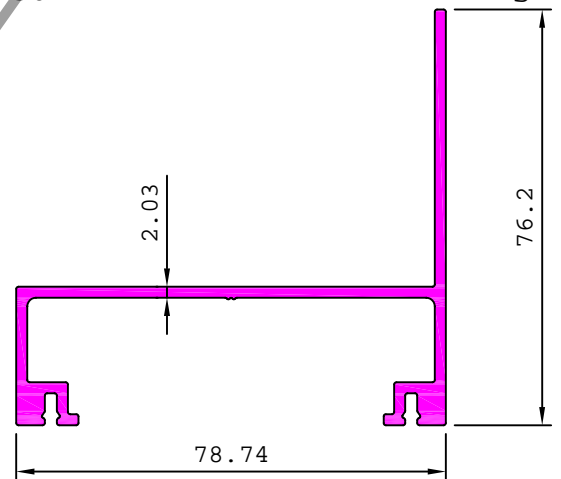
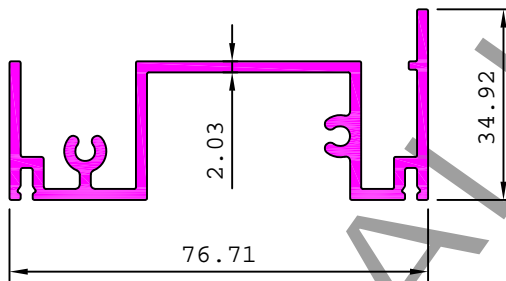

22931

1.596 kg/m

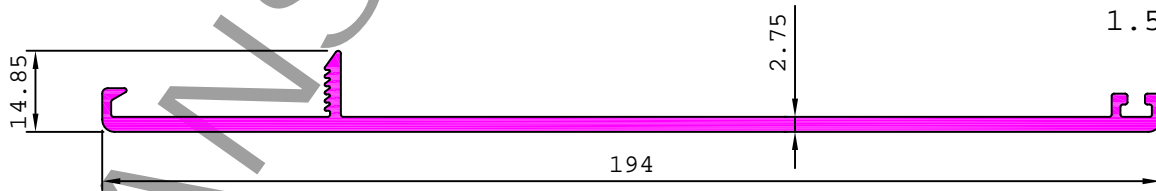

22932

0.653 kg/m

22935

0.491 kg/m

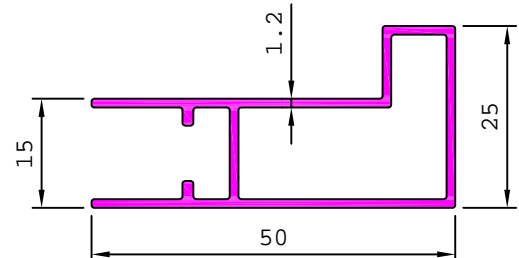
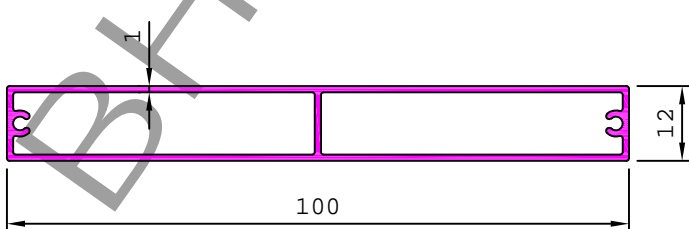

ARCHITECTURAL

MISCELLANEOUS

22933

2.220 kg/m

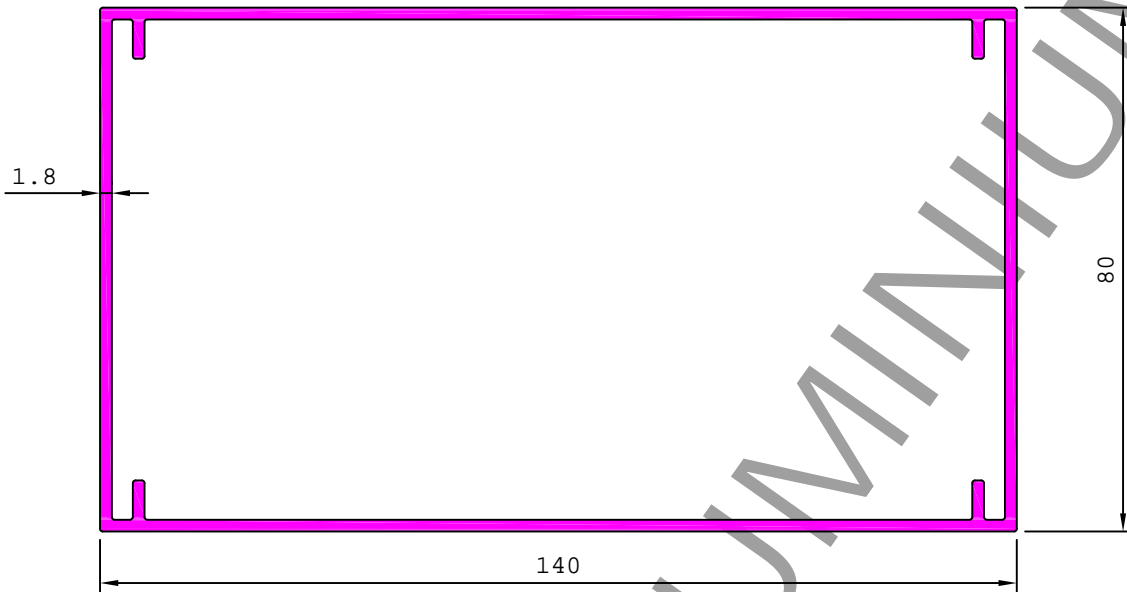

22934 0.064 kg/m

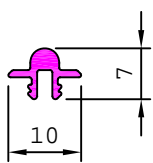

22940 0.081 kg/m

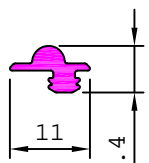

29058 0.095 kg/m

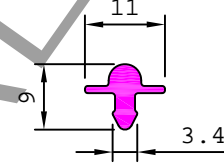

29416 0.135 kg/m

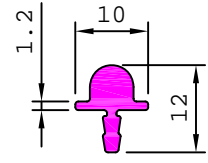

22938

1.146 kg/m

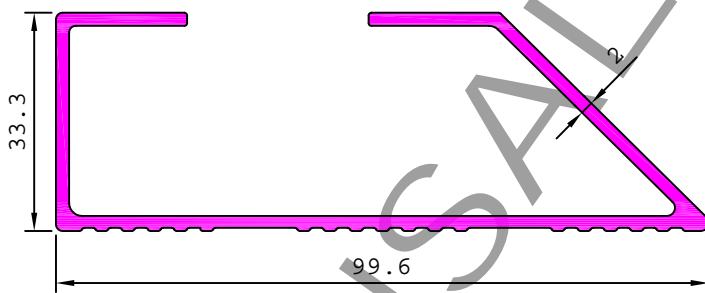

22939

1.294 kg/m

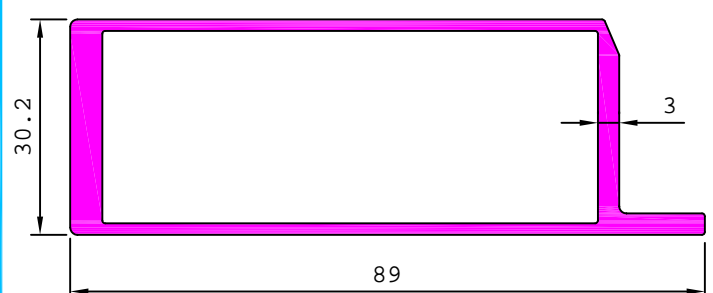

15200

0.873 kg/m

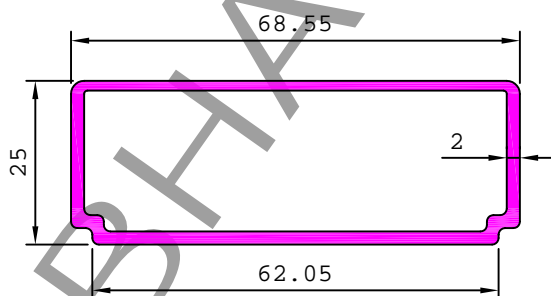

15201

0.578 kg/m

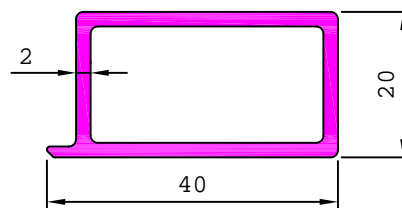

15231

0.300 kg/m

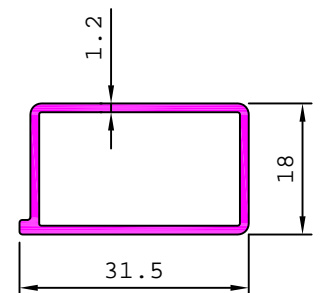

ARCHITECTURAL

MISCELLANEOUS

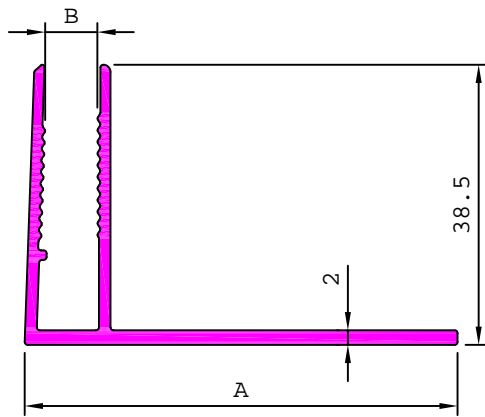

SL. No.	Section No.	A	B	Weight kg/m
1	28992	59.50	7.19	0.630
2	28994	63.50	11.19	0.651
3	28993	67.50	15.02	0.678

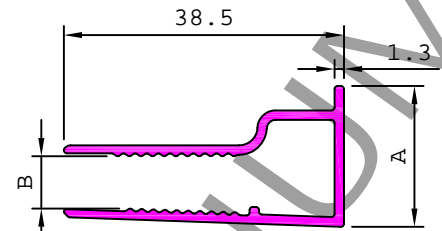

SL. No.	Section No.	A	B	Weight kg/m
1	28983	19.35	7.19	0.332
2	28984	23.35	11.02	0.351

28985

0.181 kg/m

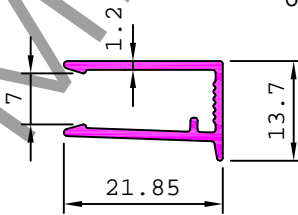

28914

0.423 kg/m

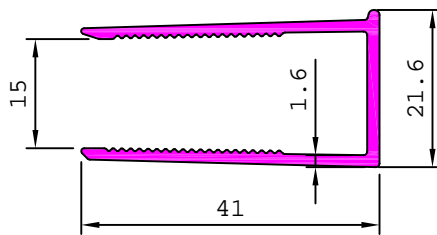

28972

0.365 kg/m

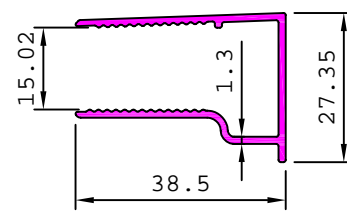

29005

0.375 kg/m

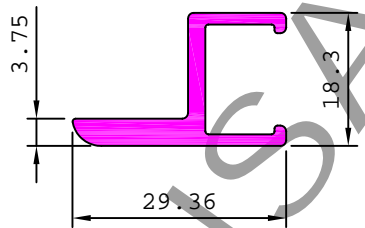

29442

0.807 kg/m

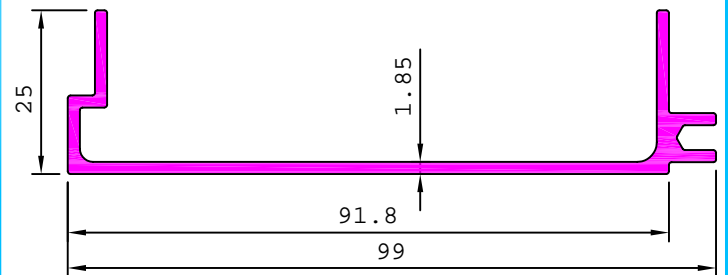

35690

3.771 kg/m

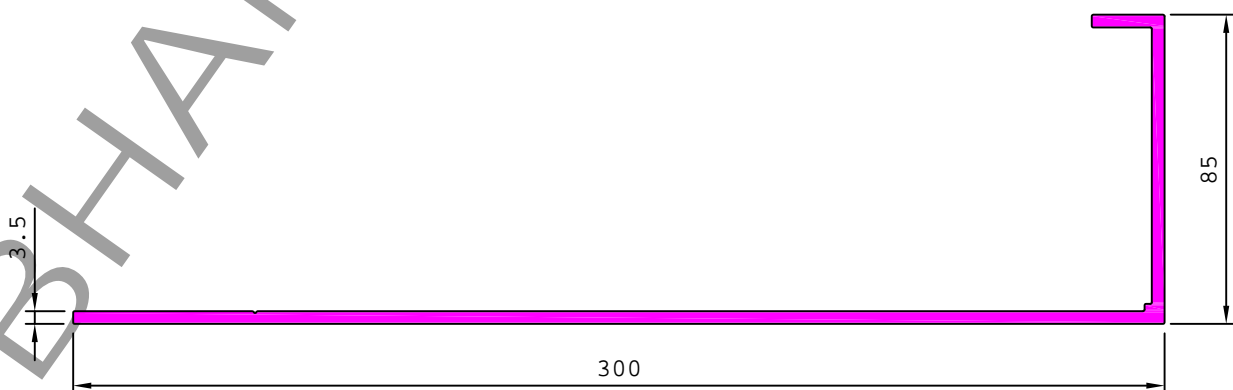

ARCHITECTURAL

MISCELLANEOUS

35776

2.216 kg/m

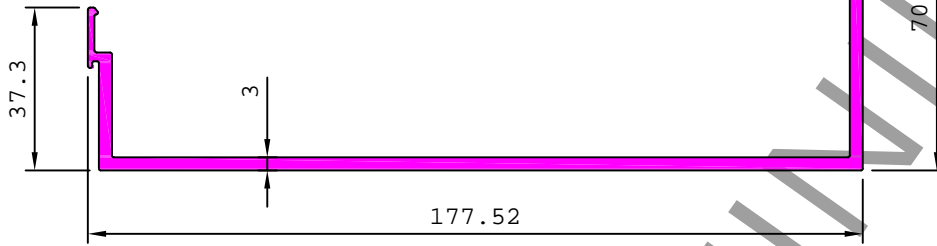

29415

1.106 kg/m

27956

1.354 kg/m

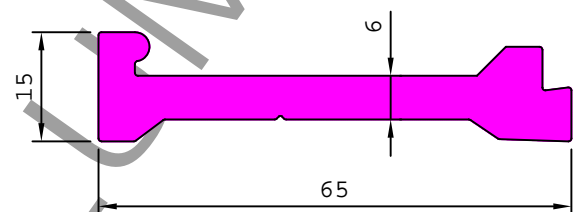
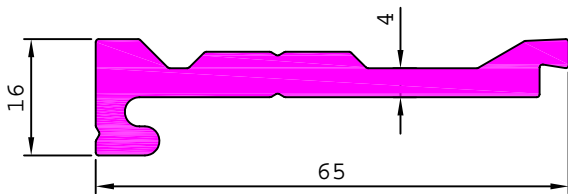

29117

0.287 kg/m

29360

1.054 kg/m

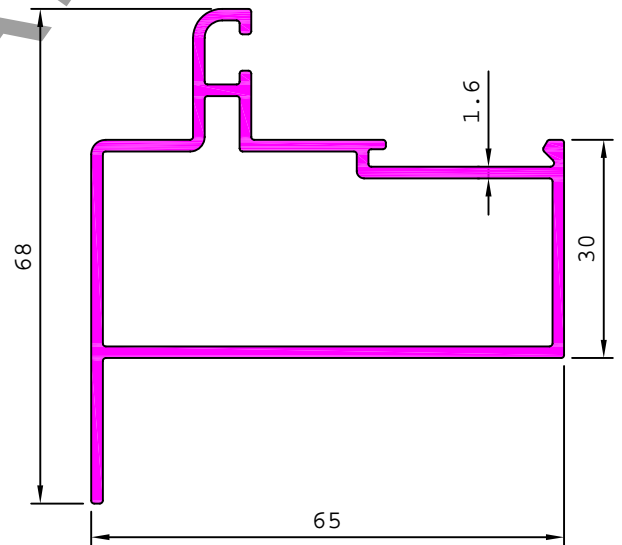
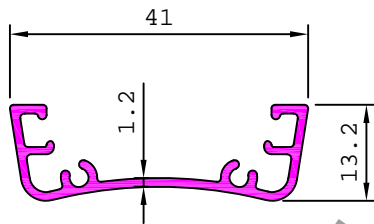

S3246

0.329 kg/m

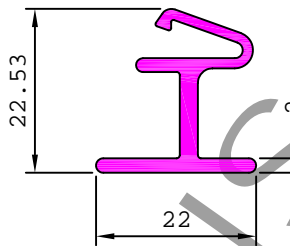

S3243

0.939 kg/m

S3244

1.084 kg/m

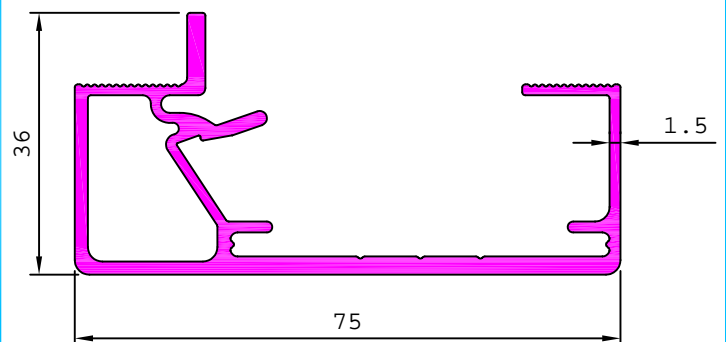
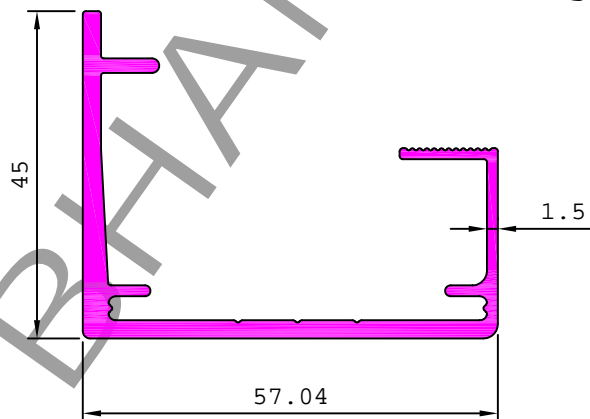

ARCHITECTURAL

MISCELLANEOUS

29446

2.286 kg/m

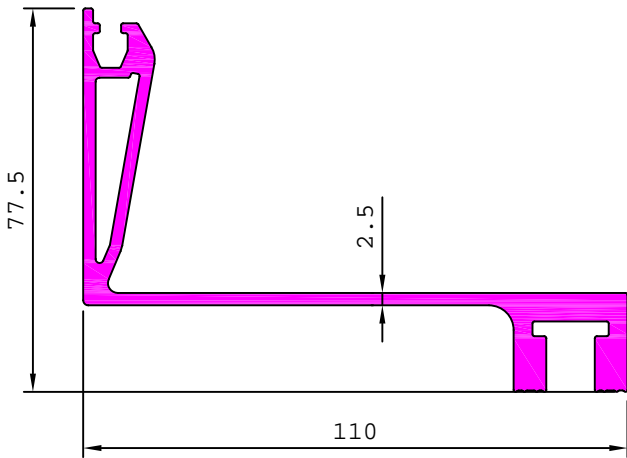

29546

0.638 kg/m

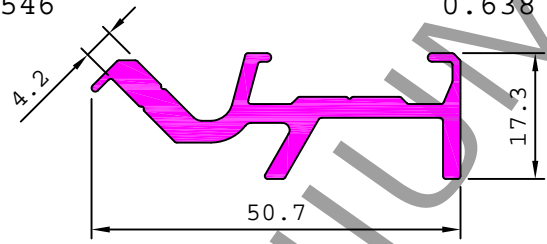

29545

0.656 kg/m

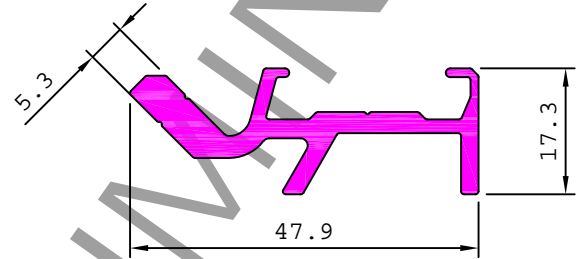

35070

0.481 kg/m

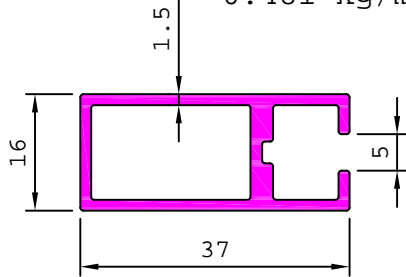

29514

0.478 kg/m

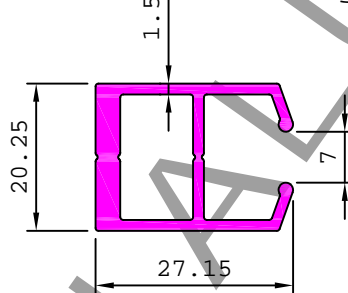

S3780

0.631 kg/m

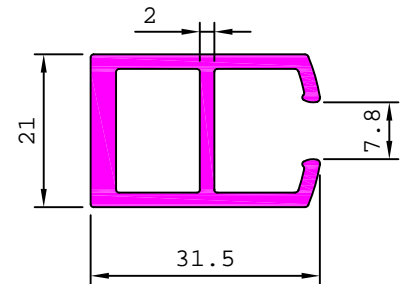

S3387

1.308 kg/m

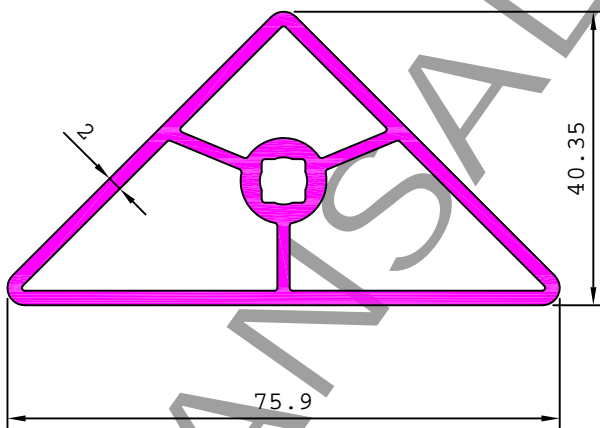

S3463

0.884 kg/m

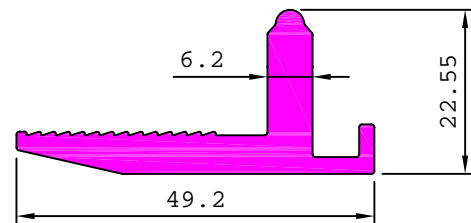

S3464

0.601 kg/m

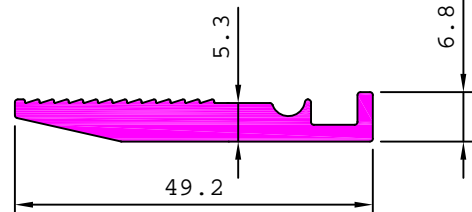

S3388

1.889 kg/m

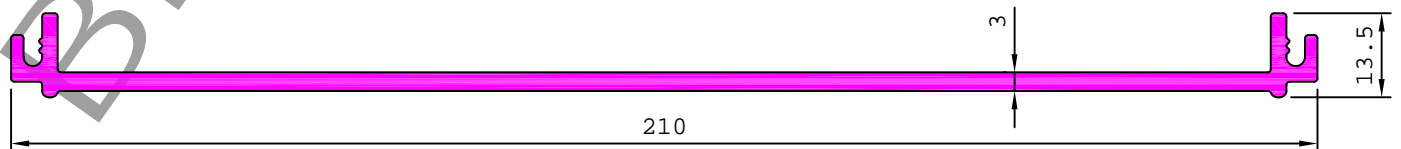

ARCHITECTURAL

MISCELLANEOUS

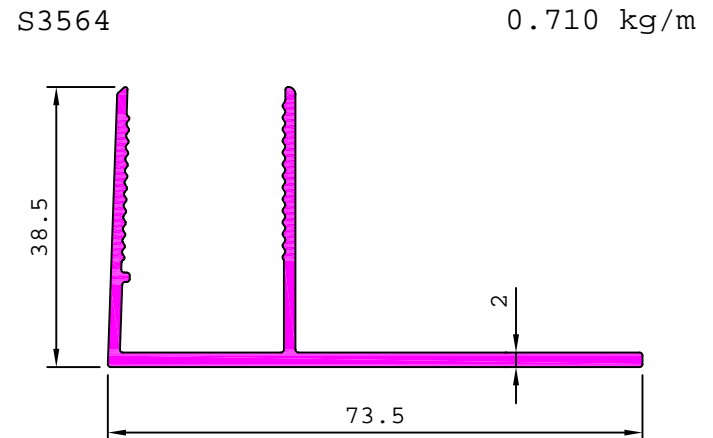
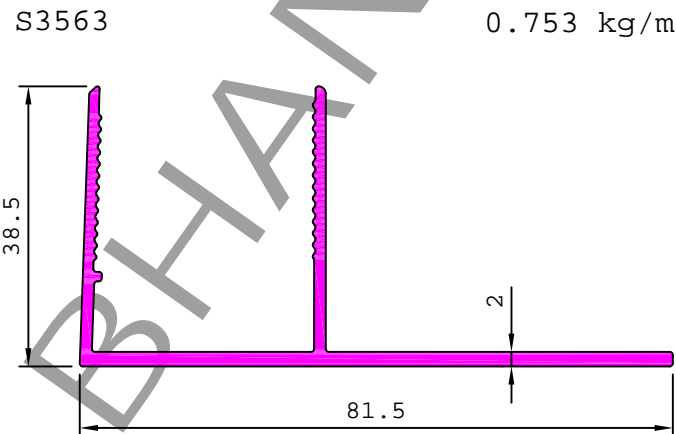
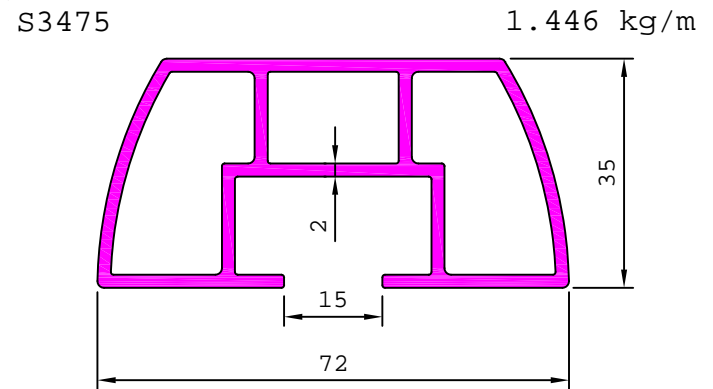
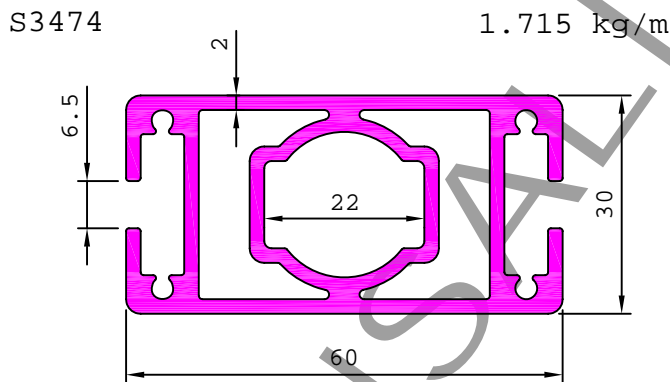
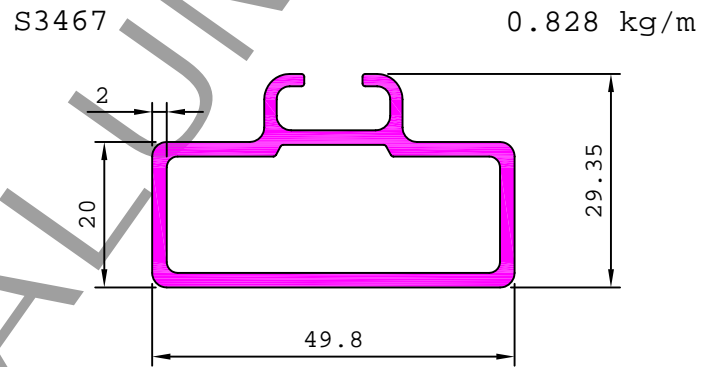
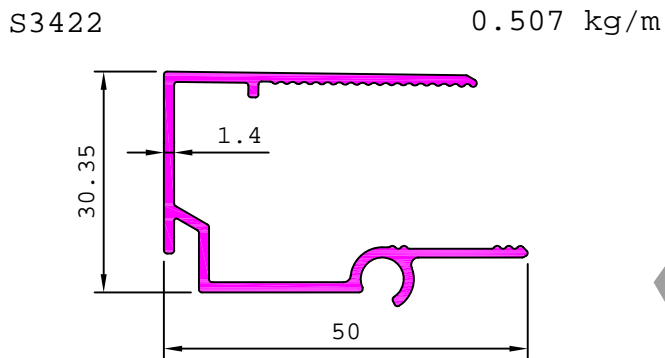
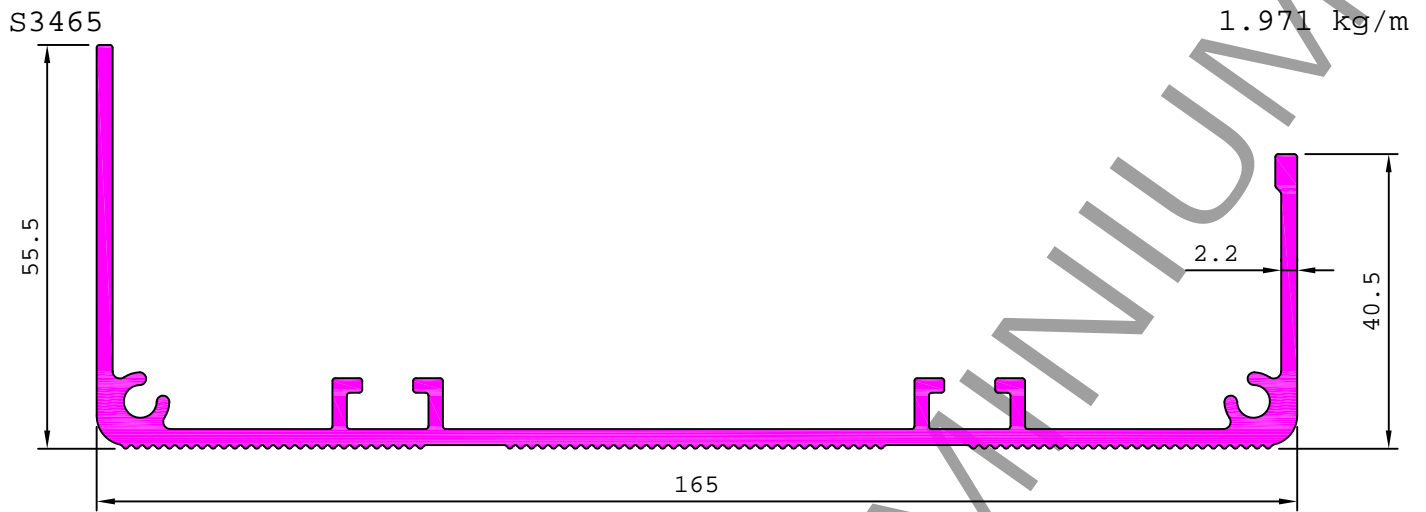

ARCHITECTURAL

MISCELLANEOUS

S3565

0.523 kg/m

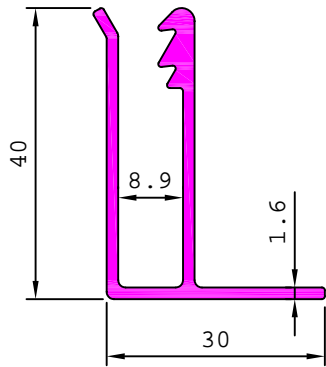

S3566

3.145 kg/m

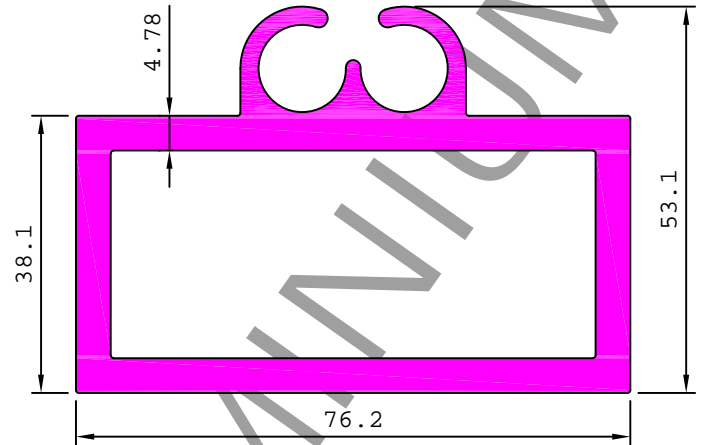

S3621

0.845 kg/m

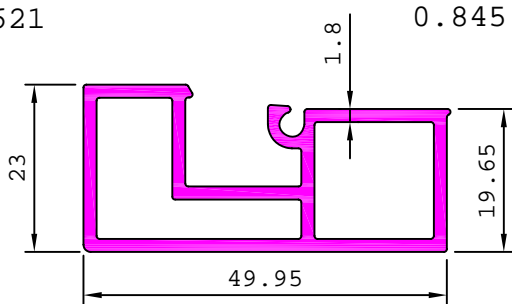

S3622

0.597 kg/m

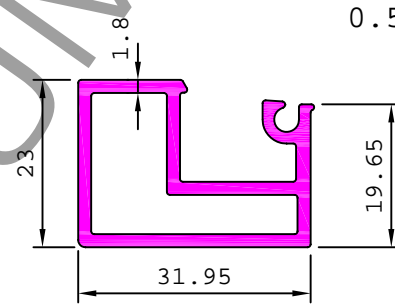

S3623

0.171 kg/m

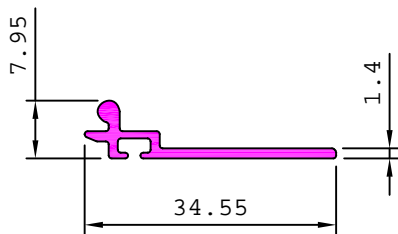

S3627

1.662 kg/m

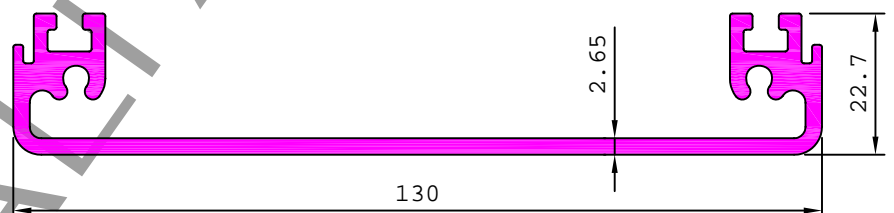

S3688

3.232 kg/m

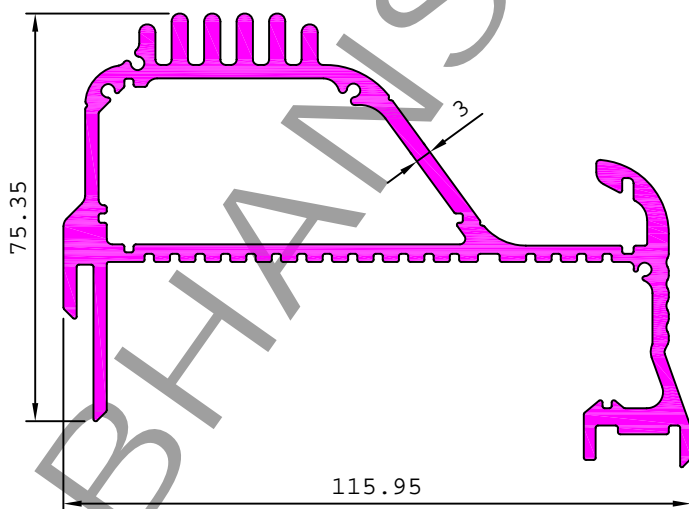

S3716

0.133 kg/m

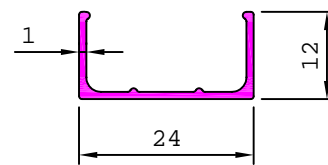

S3717

0.119 kg/m

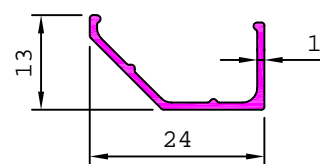

ARCHITECTURAL

MISCELLANEOUS

S3713

0.405 kg/m

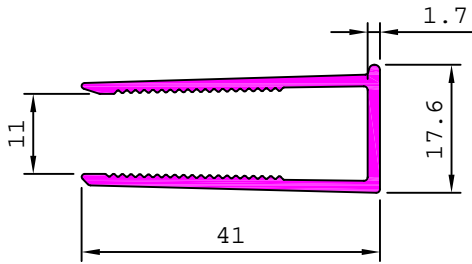

S3714

0.386 kg/m

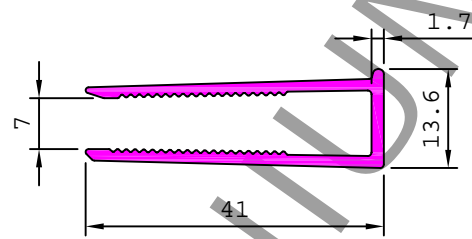

S3843

0.383 kg/m

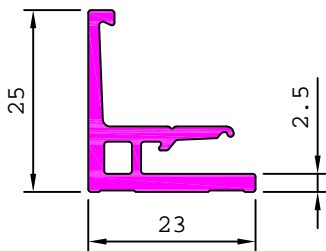

S3842

0.180 kg/m

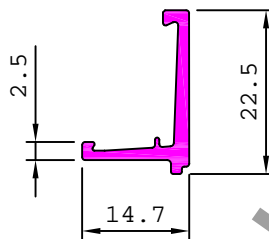

S3833

0.225 kg/m

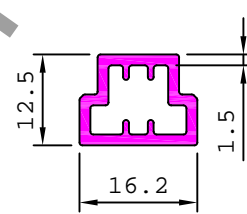

S3888

0.335 kg/m

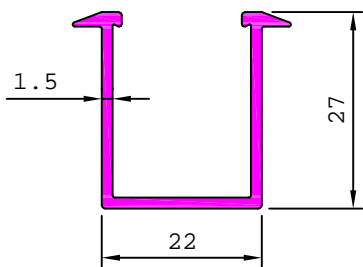

S3901

0.445 kg/m

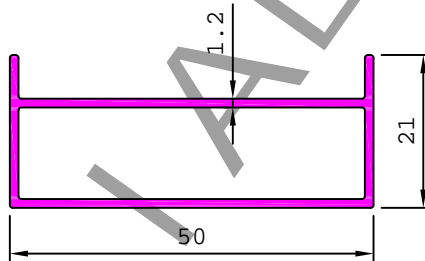

S3903

0.588 kg/m

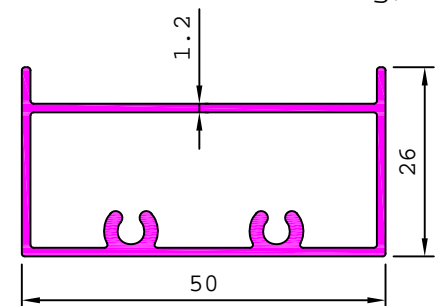

S3920

0.487 kg/m

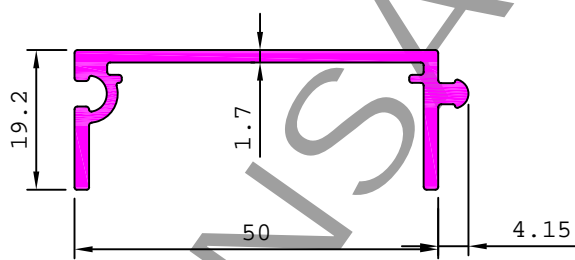

S3931

0.307 kg/m

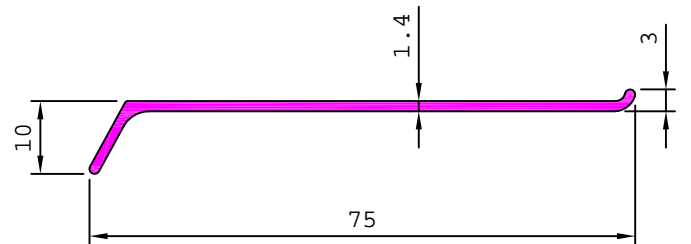

S3952

0.081 kg/m

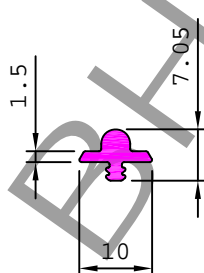

S3953

0.192 kg/m

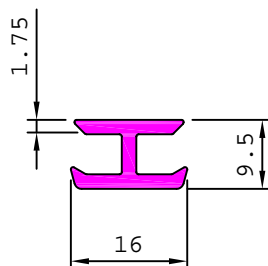

S3998

0.116 kg/m

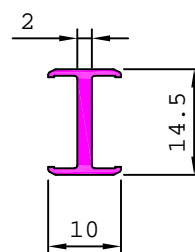

S4080

0.050 kg/m

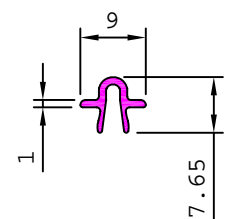

ARCHITECTURAL

MISCELLANEOUS

S3954 0.789 kg/m

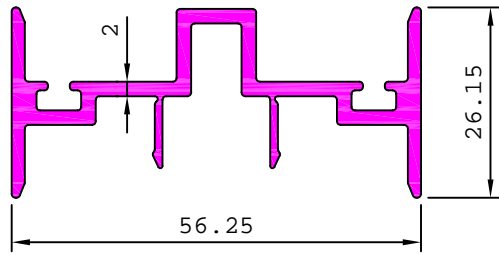

S3955 0.472 kg/m

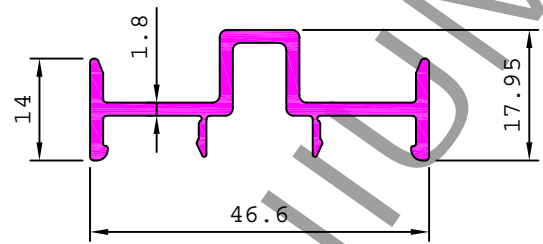

S3989 1.069 kg/m

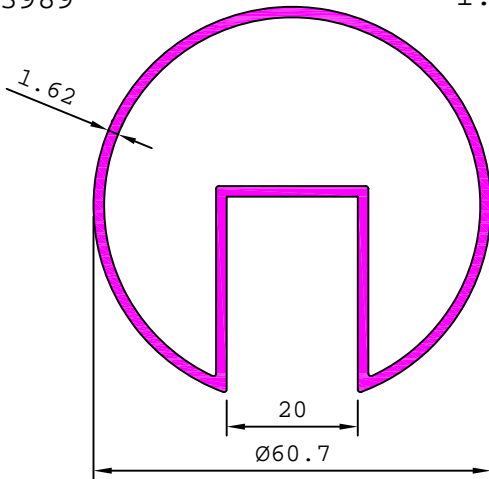

S3512 0.463 kg/m

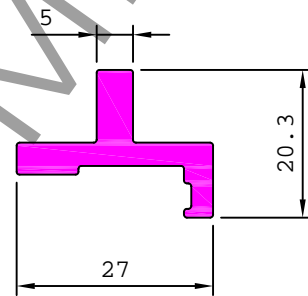

S4083 0.228 kg/m

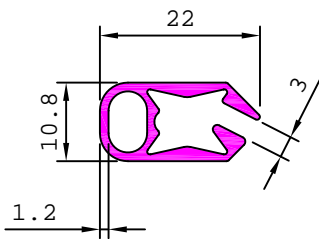

S4091 0.517 kg/m

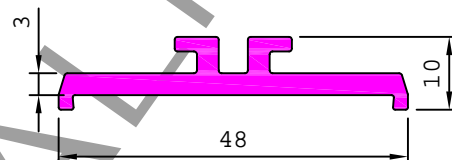

S4099 0.359 kg/m

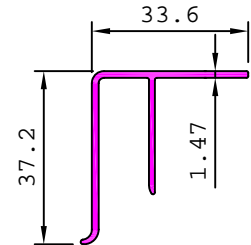

S4100 0.429 kg/m

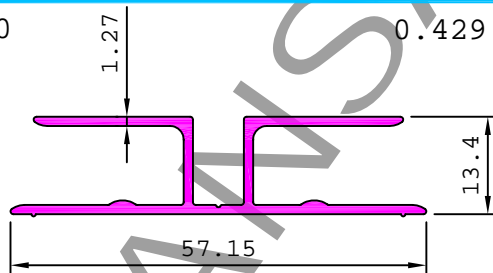

S4101 0.347 kg/m

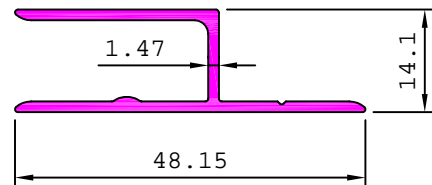

S4103 0.614 kg/m

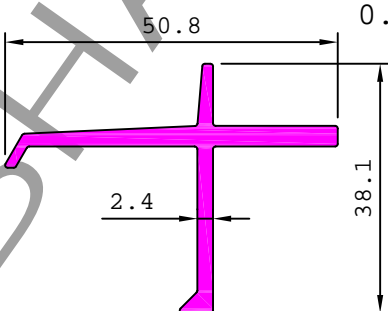

S4104 0.827 kg/m

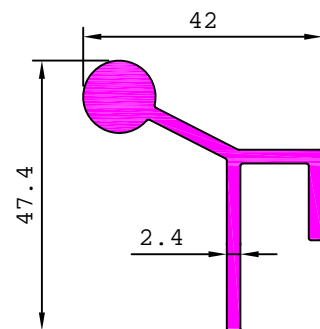

ARCHITECTURAL

MISCELLANEOUS

S4102

2.311 kg/m

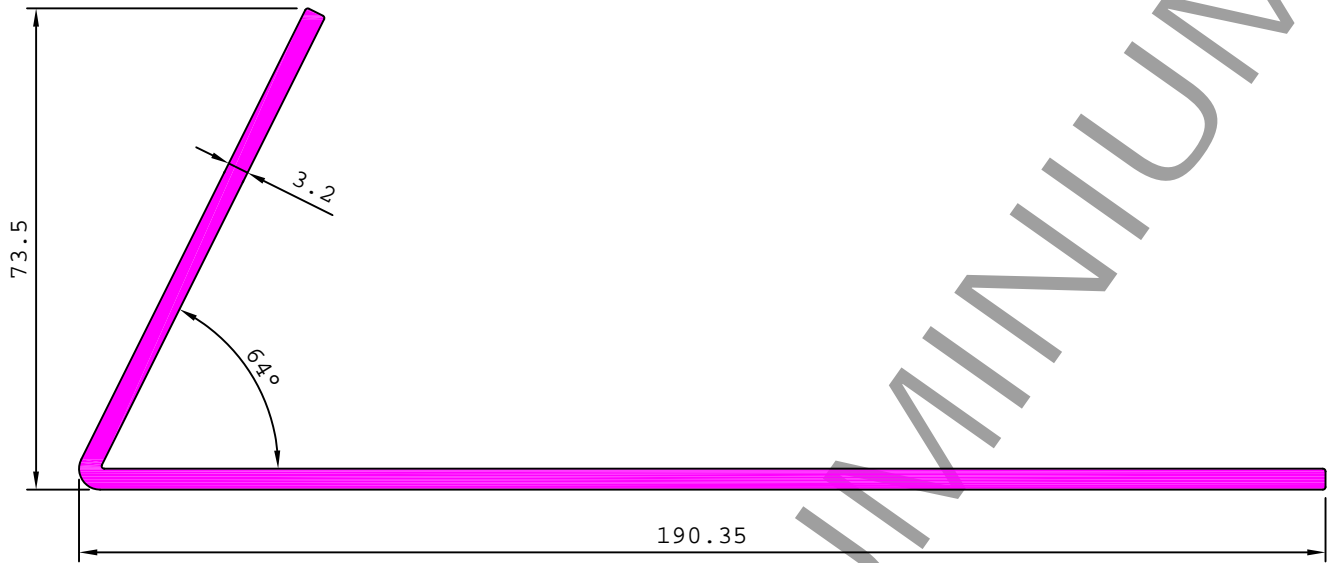

S4105

0.611 kg/m

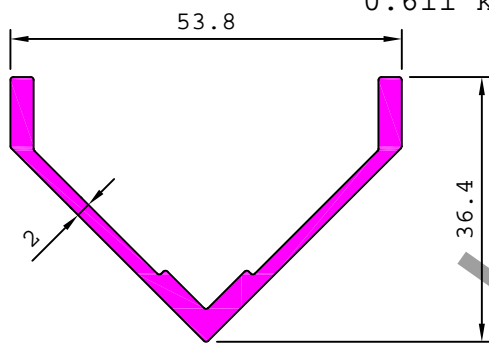

S4106

2.092 kg/m

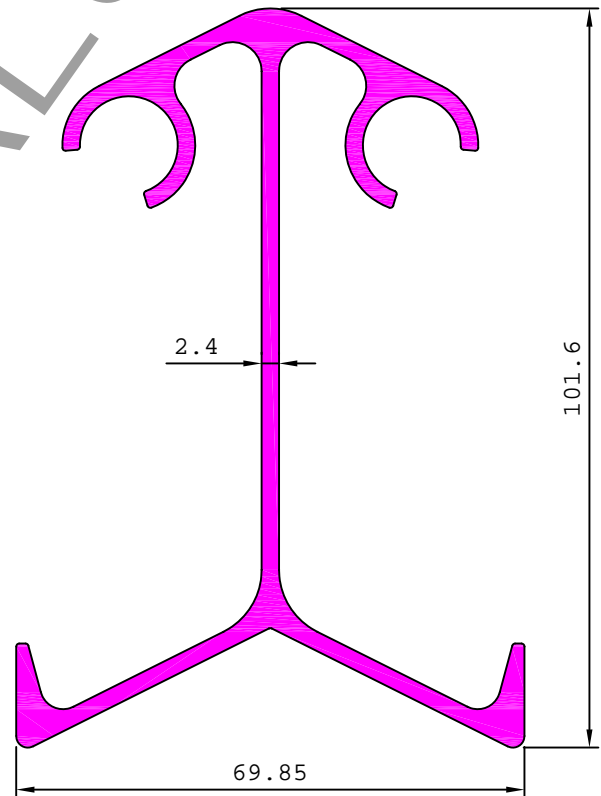

S4108

0.634 kg/m

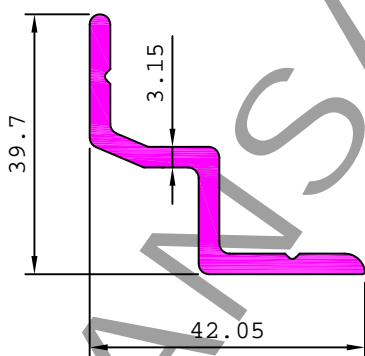

S4109

0.428 kg/m

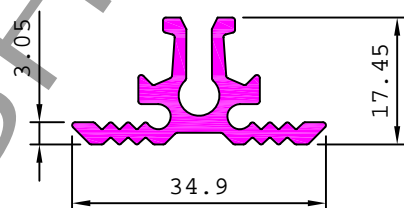

S4137

0.198 kg/m

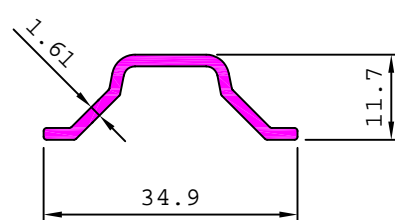

ARCHITECTURAL

MISCELLANEOUS

S4054

1.235 kg/m

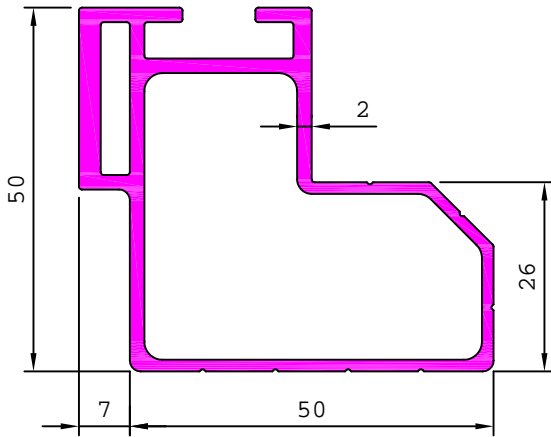

25179

1.124 kg/m

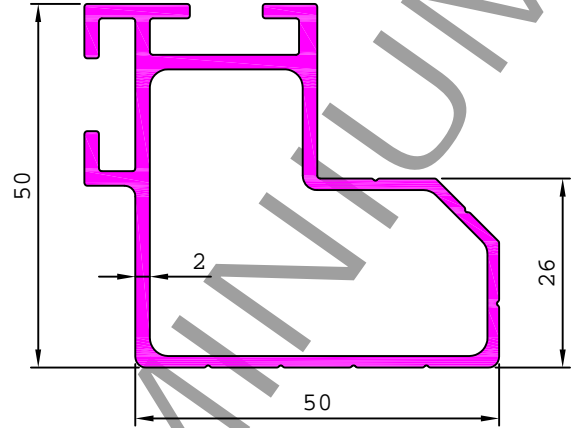

S4107

0.922 kg/m

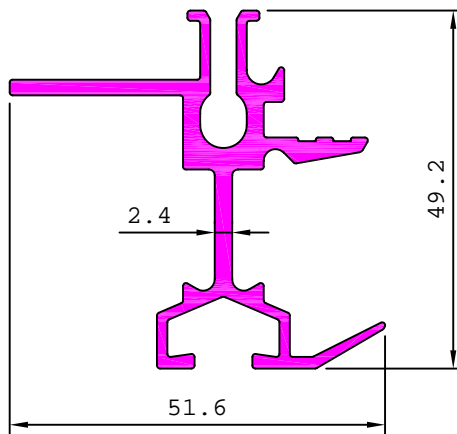

S4142

0.282 kg/m

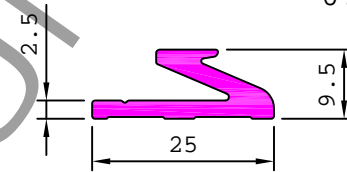

S4179

0.179 kg/m

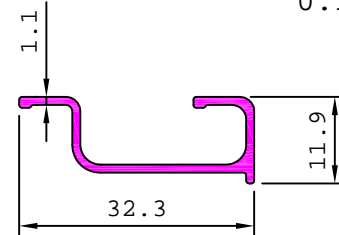

S4175

0.728 kg/m

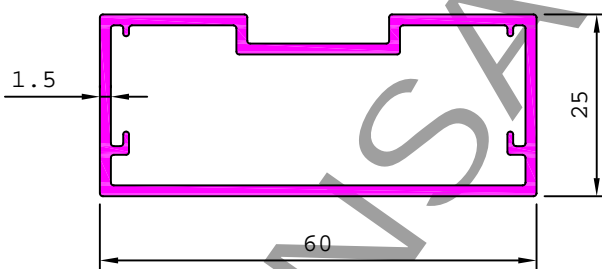

S4176

0.747 kg/m

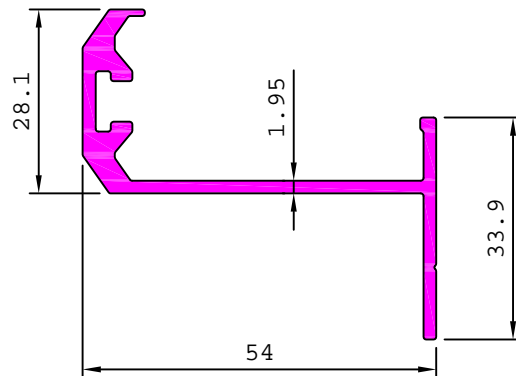

S4177

0.202 kg/m

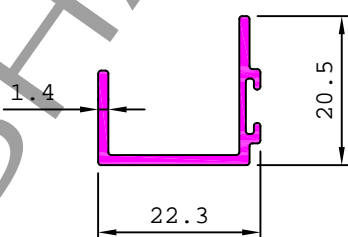

S4178

0.365 kg/m

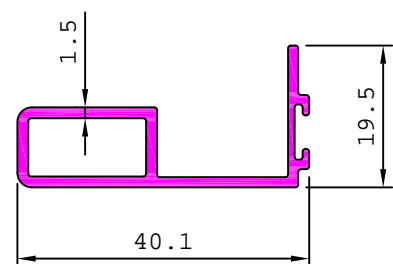

ARCHITECTURAL

MISCELLANEOUS

29372

0.473 kg/m

S4211

0.437 kg/m

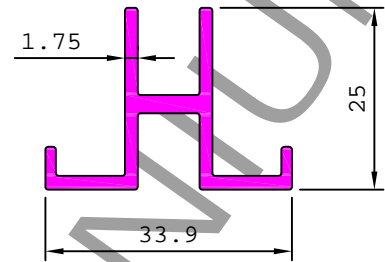
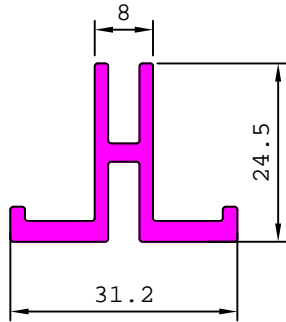

29239

0.376 kg/m

29240

0.323 kg/m

