

# TRANSPORT

## FOOT BOARDS & MISCELLANEOUS

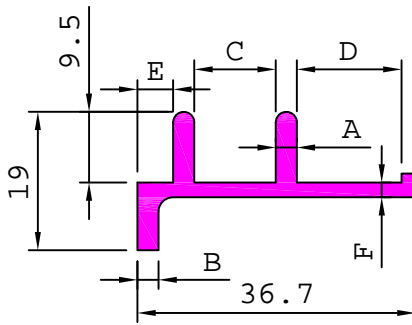

SL. No.	Section No.	A	B	C	D	E	F	Weight kg/m
1	24401	2.90	4.10	11.60	13.00	4.80	1.50	0.388
2	24413	1.60	2.40	12.60	14.10	5.70	1.10	0.248

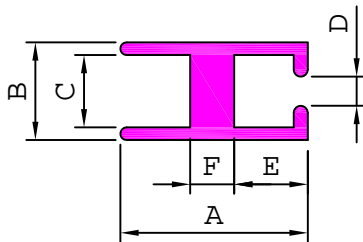

SL. No.	Section No.	A	B	C	D	E	F	Weight kg/m
1	24419	22.00	12.00	10.20	6.00	8.50	3.95	0.225
2	24416	23.60	12.60	8.25	5.40	8.60	6.30	0.434
3	24402	24.00	12.70	8.70	5.50	8.70	6.60	0.432
4	24428	24.00	12.70	9.10	5.50	9.20	5.60	0.390
5	24411	24.00	12.70	10.70	5.50	9.65	4.50	0.273
6	24454	24.00	13.00	10.40	4.30	10.30	4.50	0.316

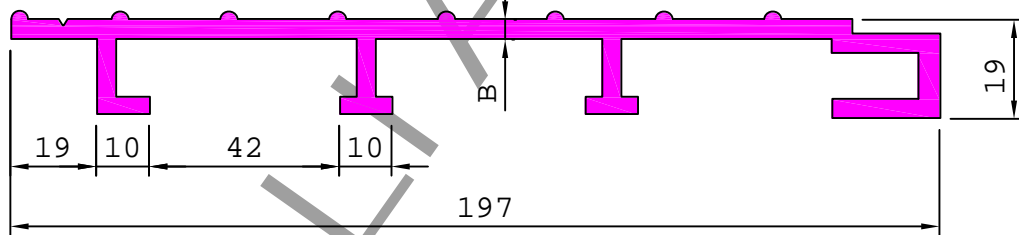

SL. No.	Section No.	B	Weight kg/m
1	24414	1.50	1.338
2	24407	1.80	1.581

24415 0.431 kg/m

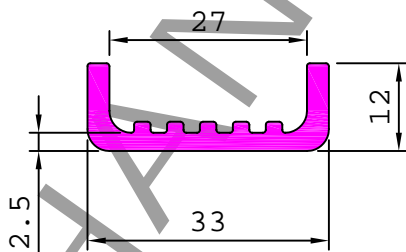

24422 0.549 kg/m

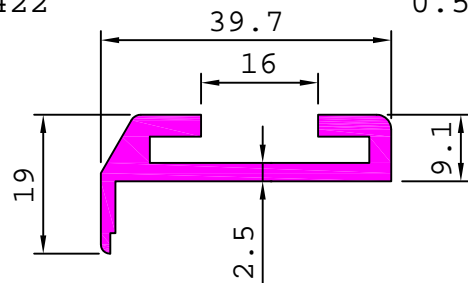

24420 0.408 kg/m

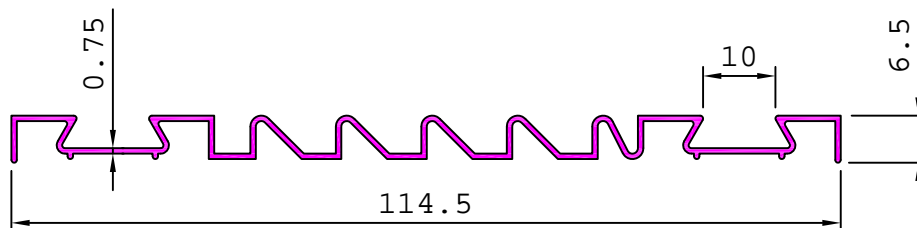

# TRANSPORT

## FOOT BOARDS & MISCELLANEOUS

24426 0.447 kg/m

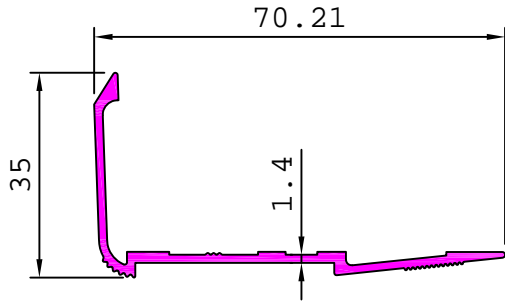

24430 0.248 kg/m

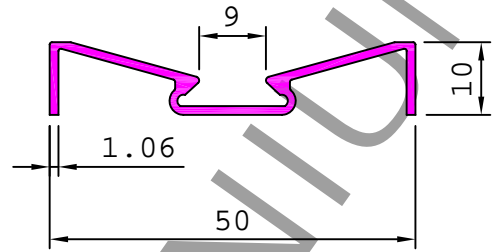

24429 0.607 kg/m

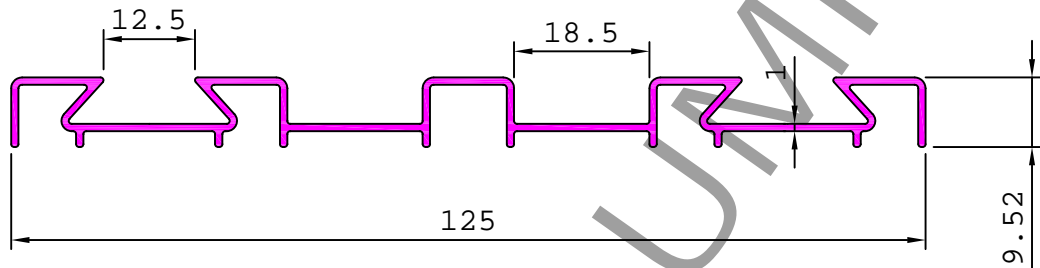

24434 0.311 kg/m

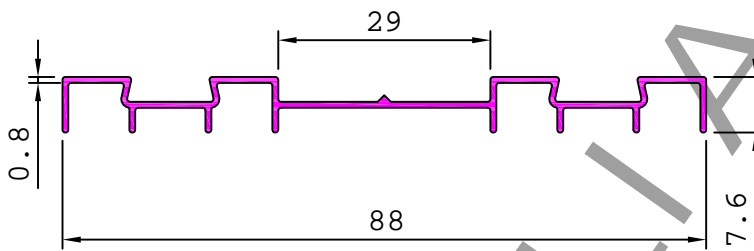

24440 1.307 kg/m

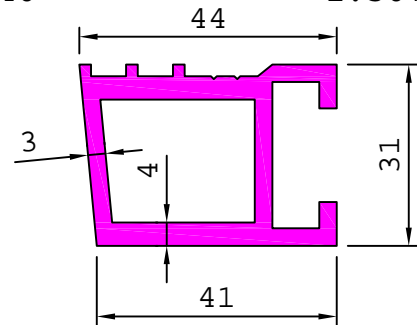

24437 1.505 kg/m

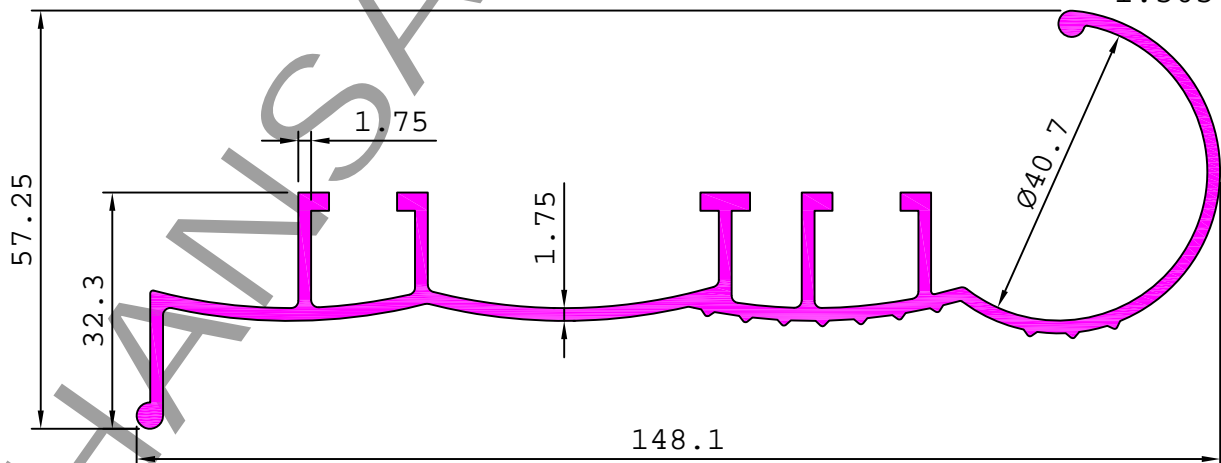

24442 0.466 kg/m

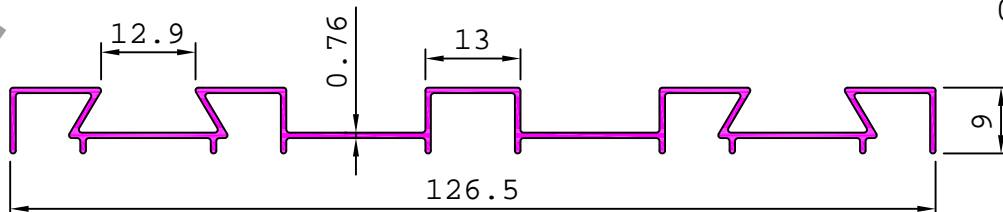

# TRANSPORT

## MISCELLANEOUS

24441 0.267 kg/m

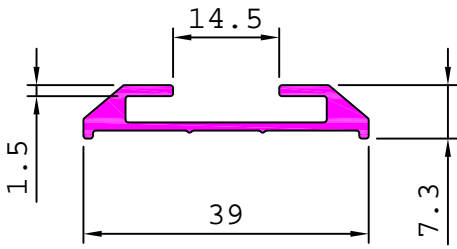

24443 1.905 kg/m

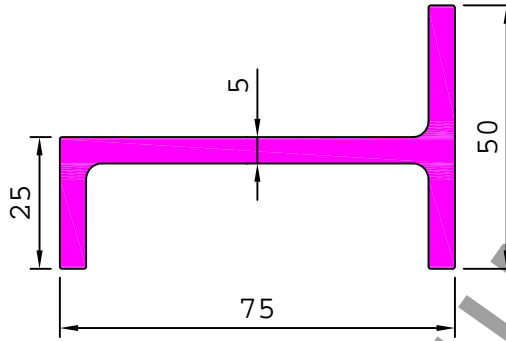

24444 1.078 kg/m

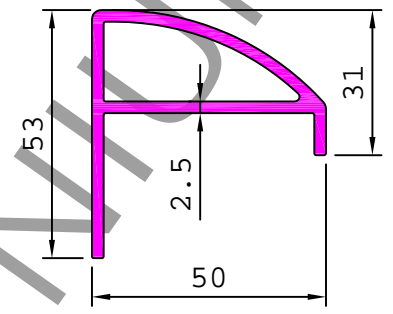

24445 2.694 kg/m

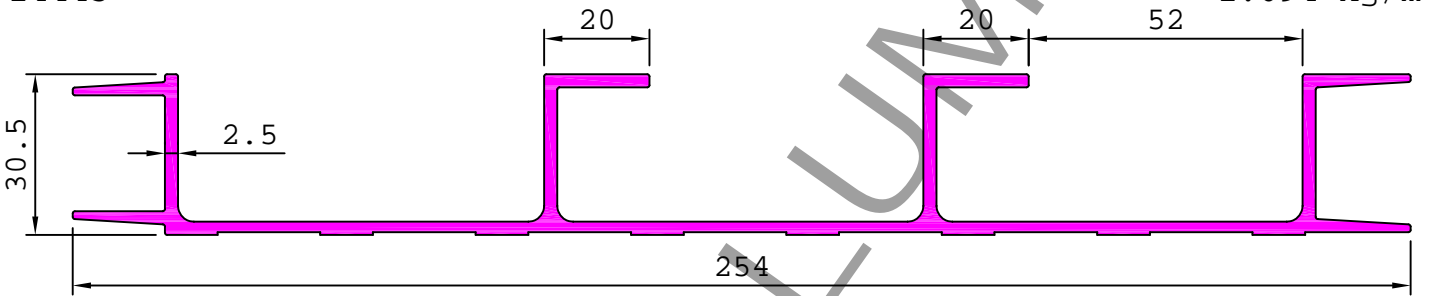

24446 2.335 kg/m

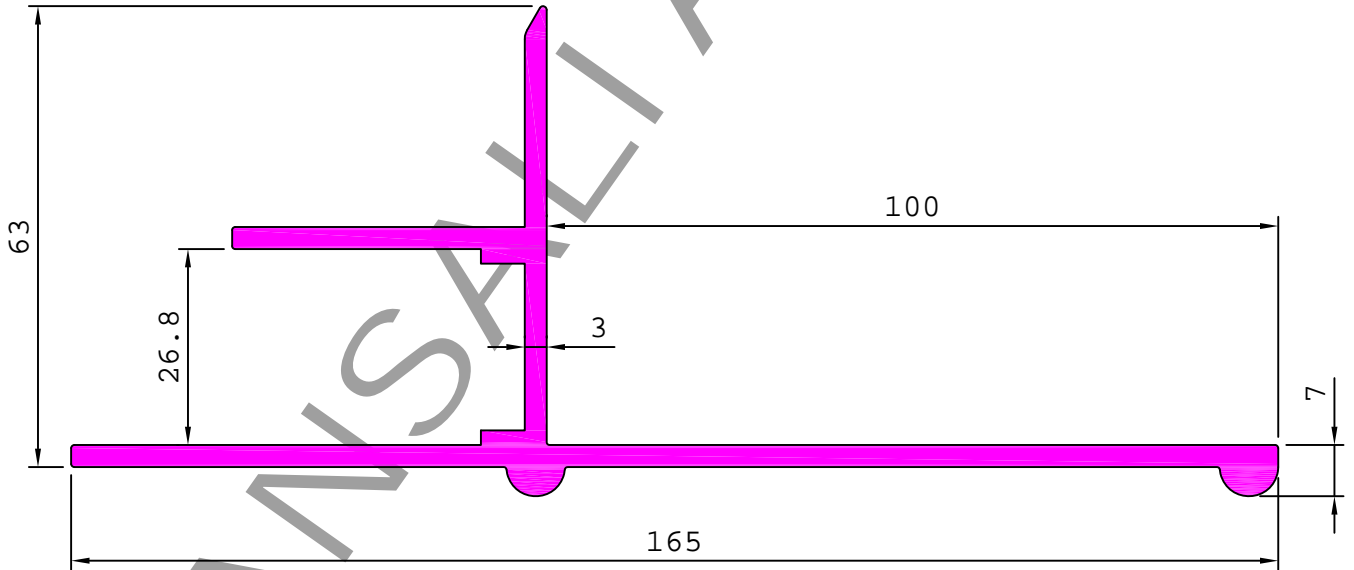

24447 1.605 kg/m

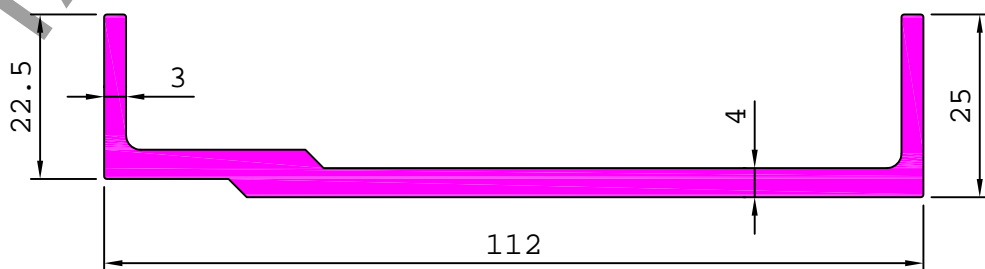

# TRANSPORT

## MISCELLANEOUS

24448

1.148 kg/m

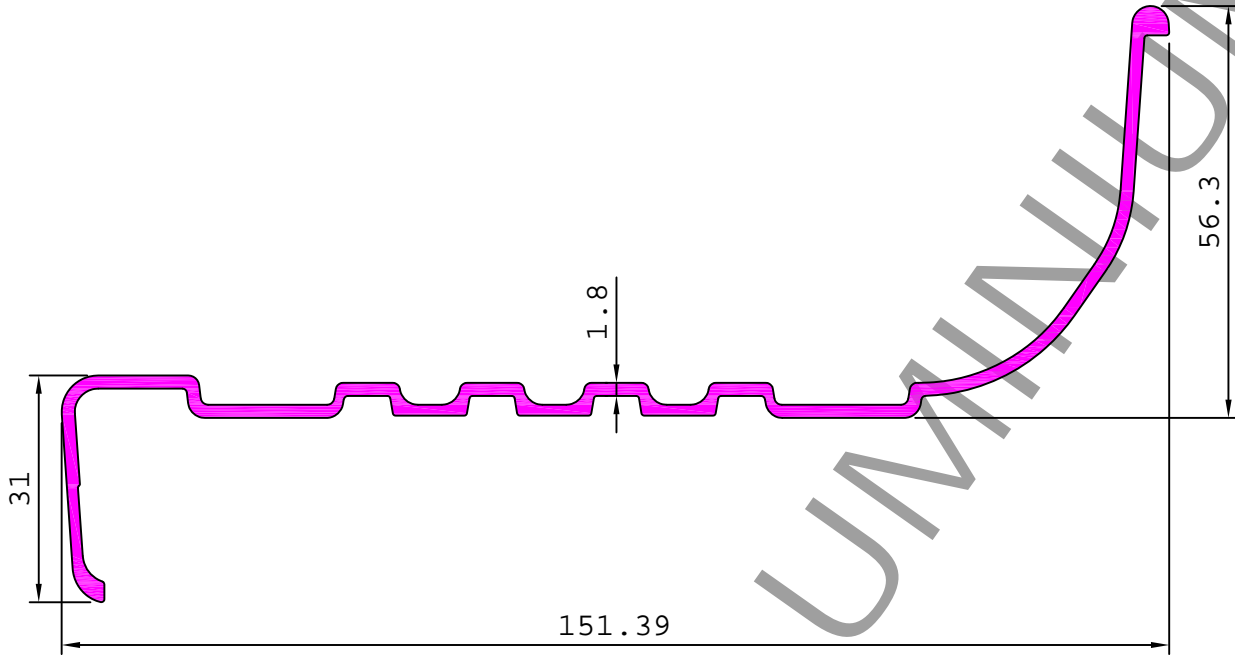

24450

1.447 kg/m

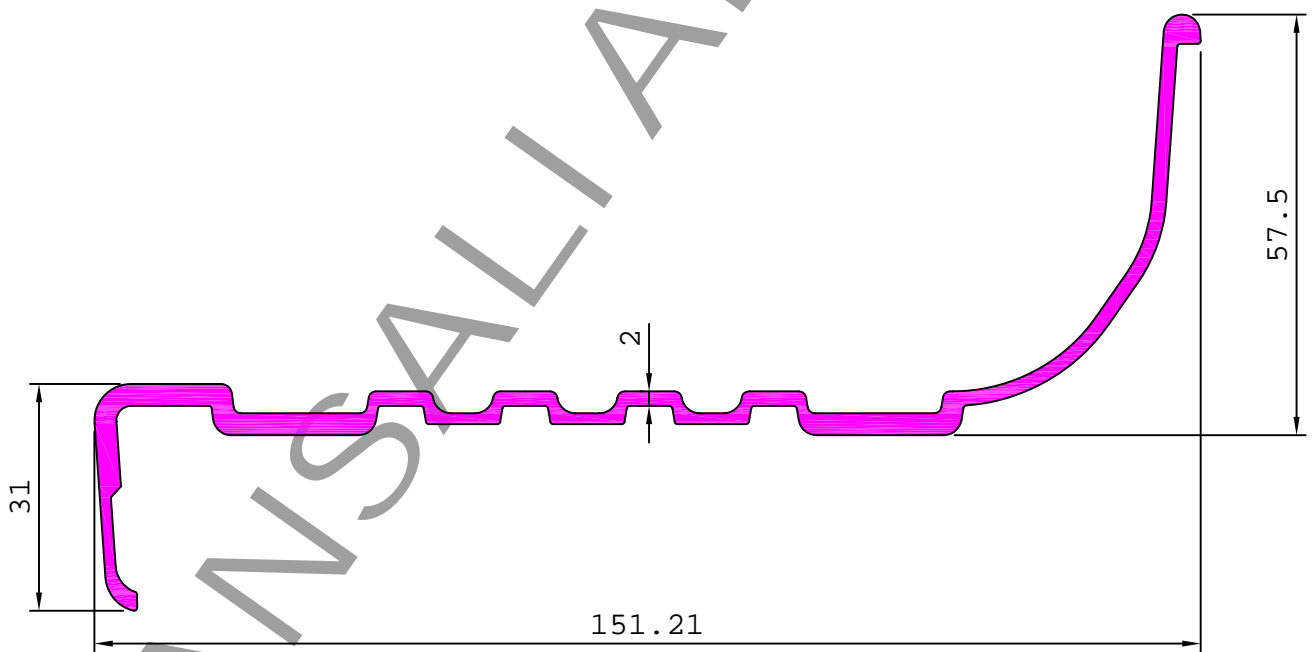

24456

0.382 kg/m

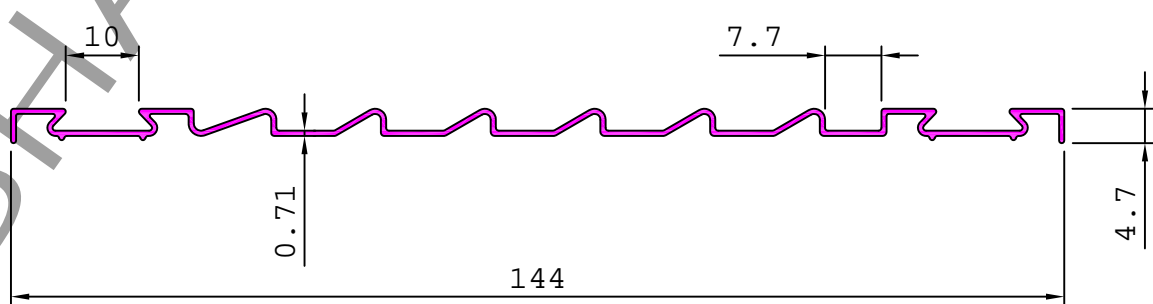

# TRANSPORT

## MISCELLANEOUS

24451 2.394 kg/m

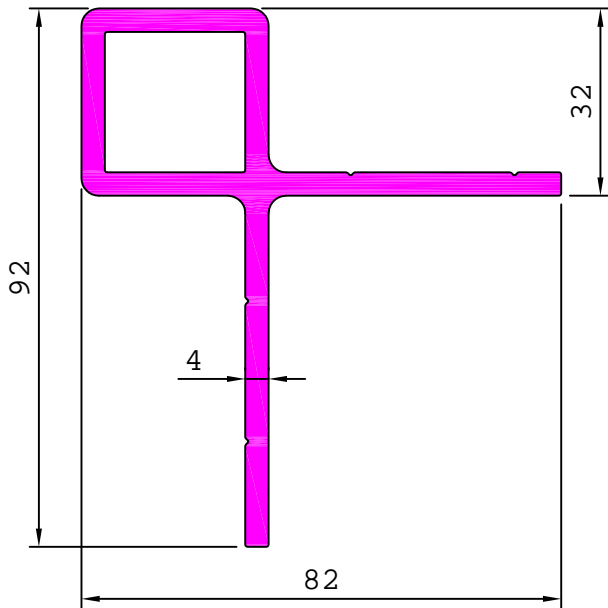

24453 0.322 kg/m

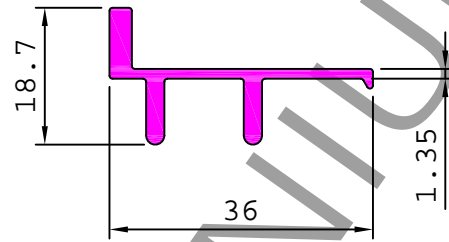

24458 0.171 kg/m

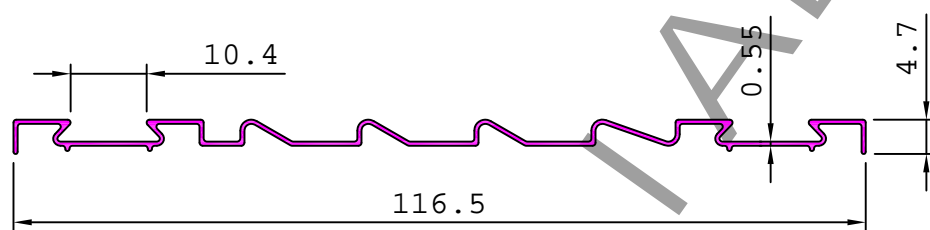
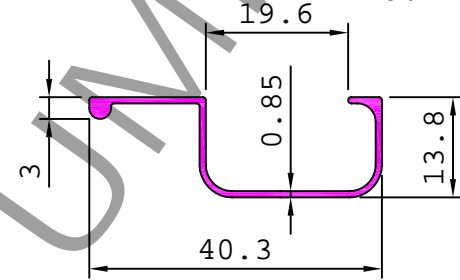

SL. No.	Section No.	B	Weight kg/m
1	24493	0.45	0.202
2	24455	0.55	0.247

24457 0.157 kg/m

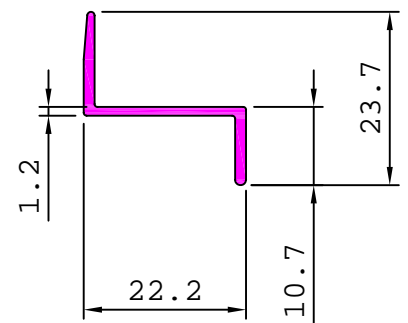

24459 1.544 kg/m

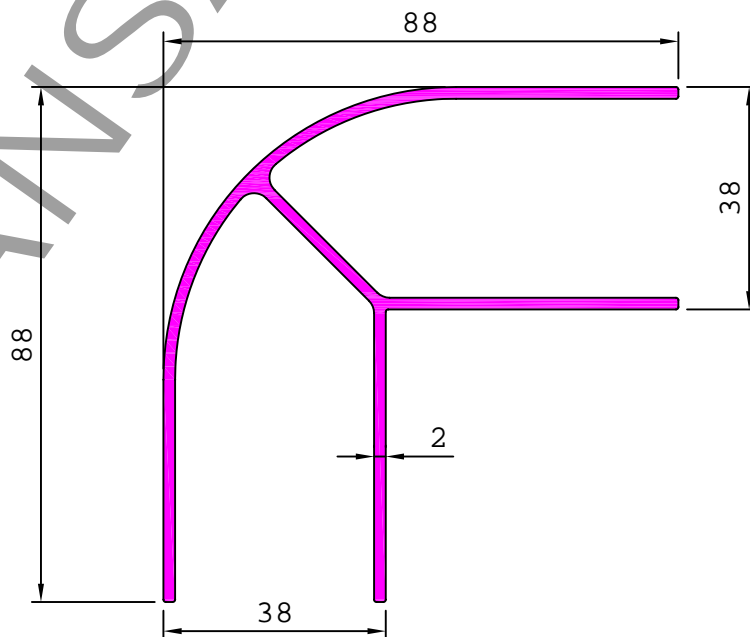

# TRANSPORT

## MISCELLANEOUS

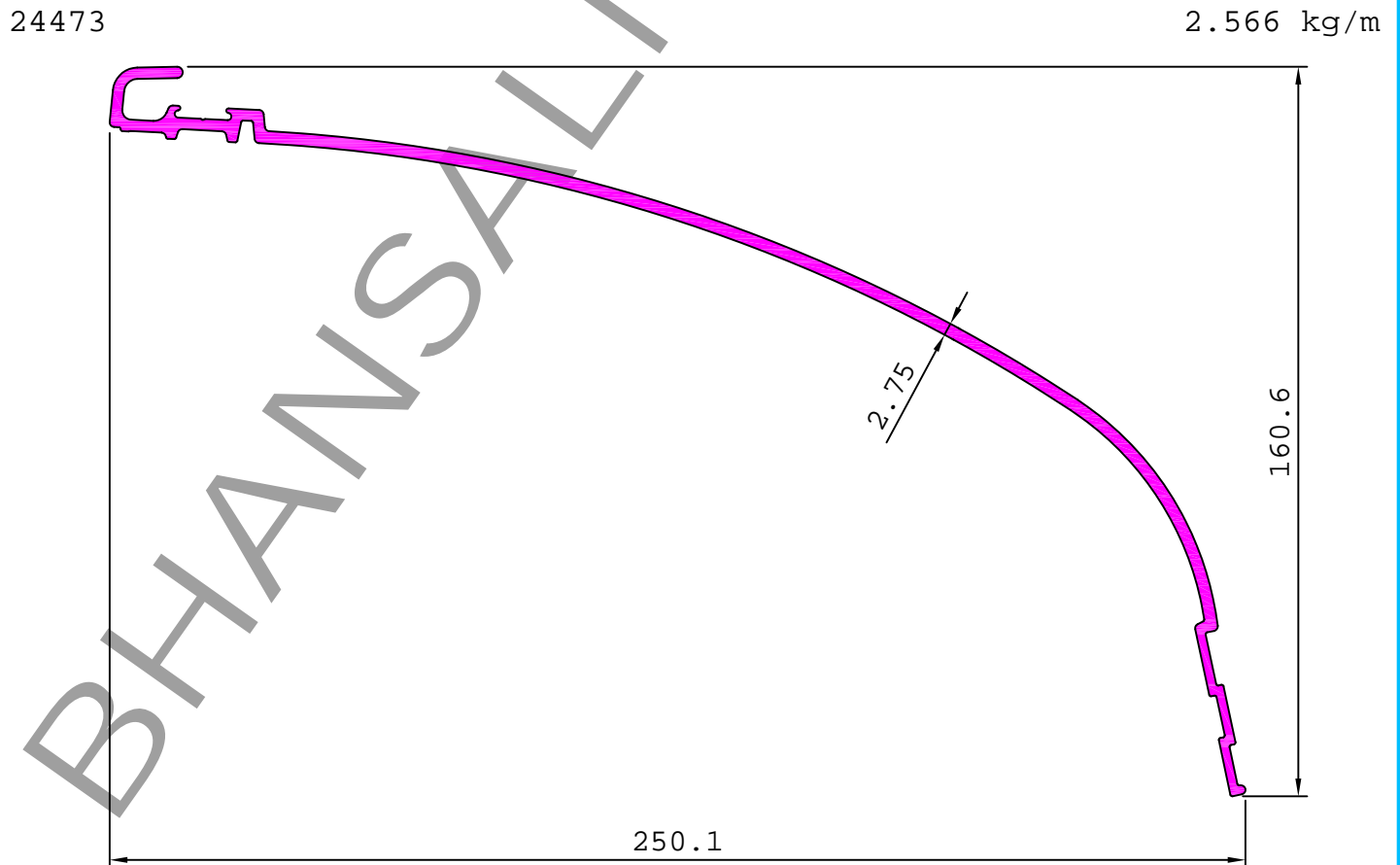
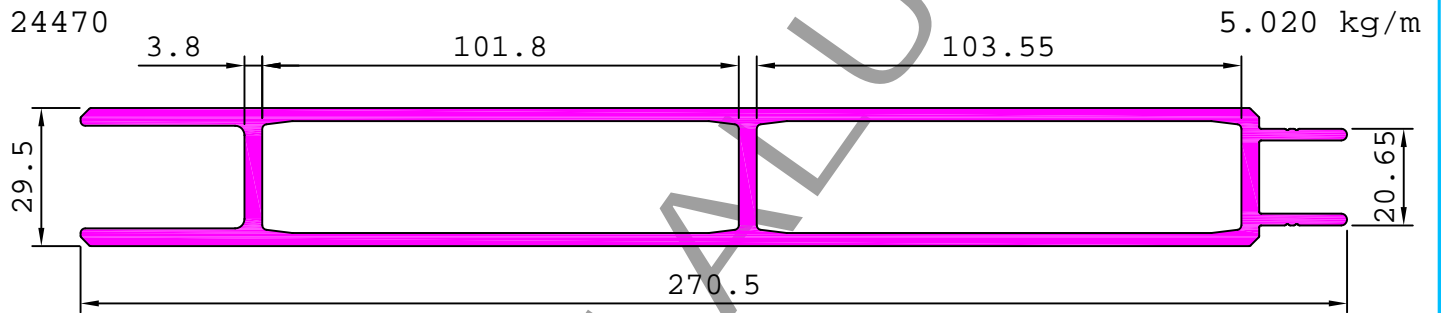
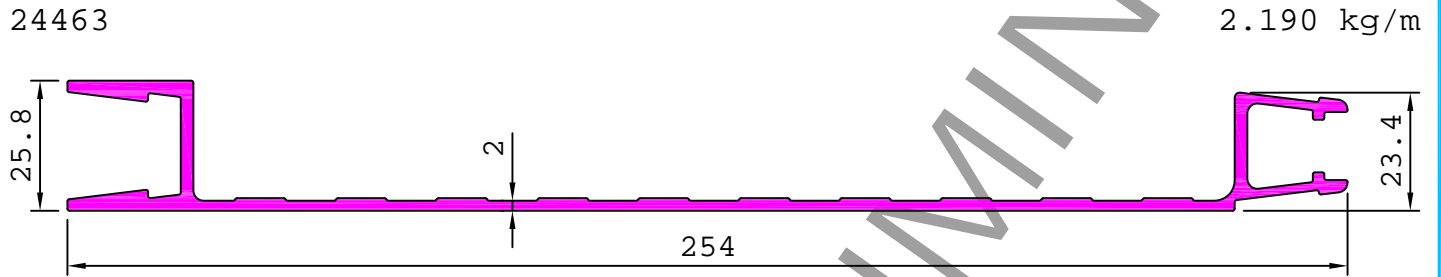
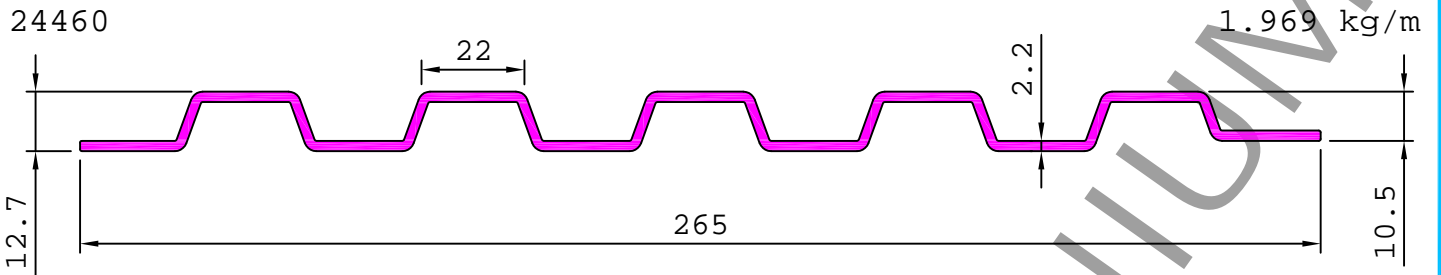

# TRANSPORT

## MISCELLANEOUS

24471 0.505 kg/m

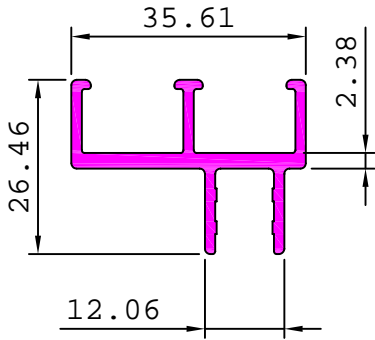

24472 1.661 kg/m

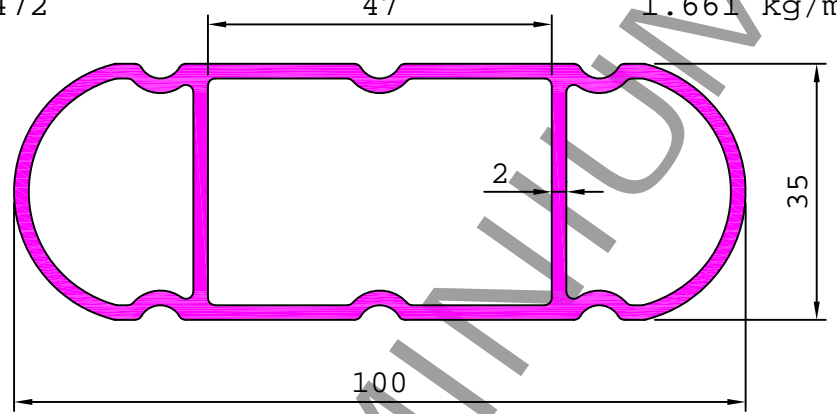

24474

1.997 kg/m

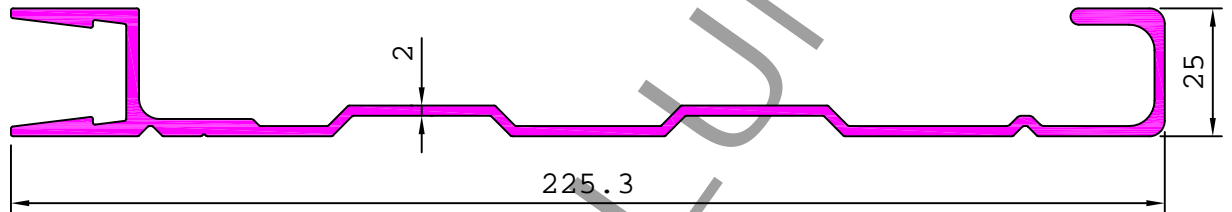

24476

1.462 kg/m

24477

1.300 kg/m

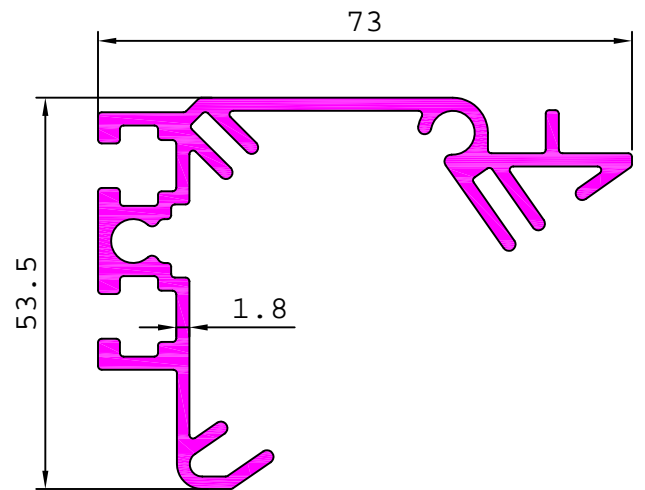
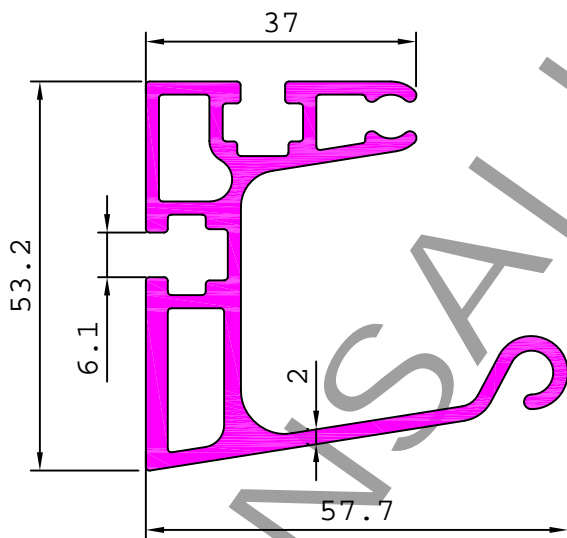

24478

3.609 kg/m

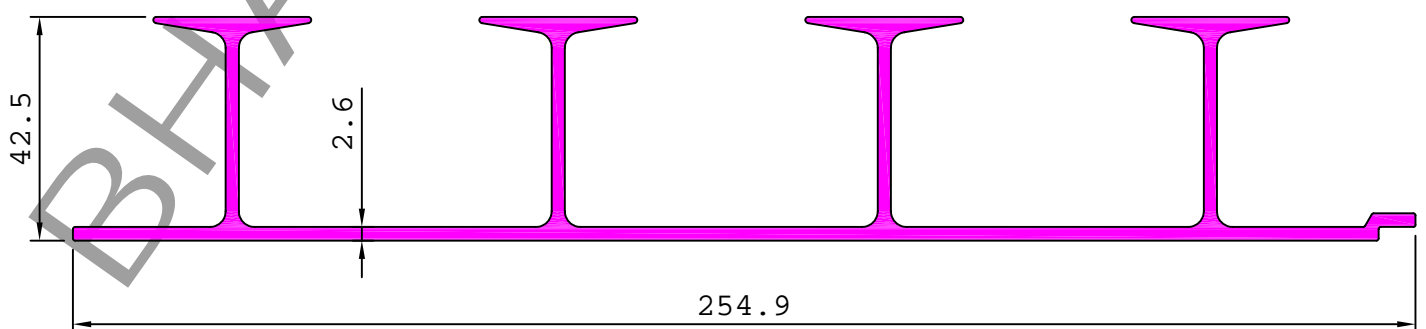

# TRANSPORT

## MISCELLANEOUS

24475 0.409 kg/m

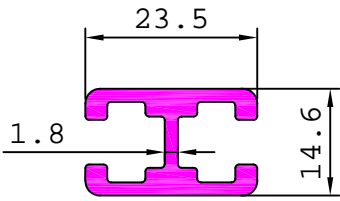

24479

1.300 kg/m

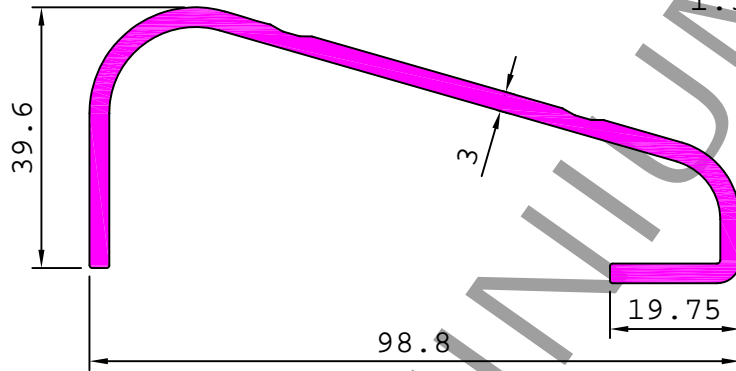

24480

0.594 kg/m

29449

0.354 kg/m

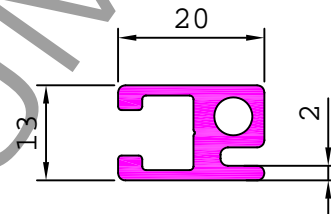
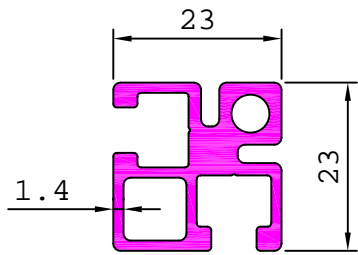

24481

3.513 kg/m

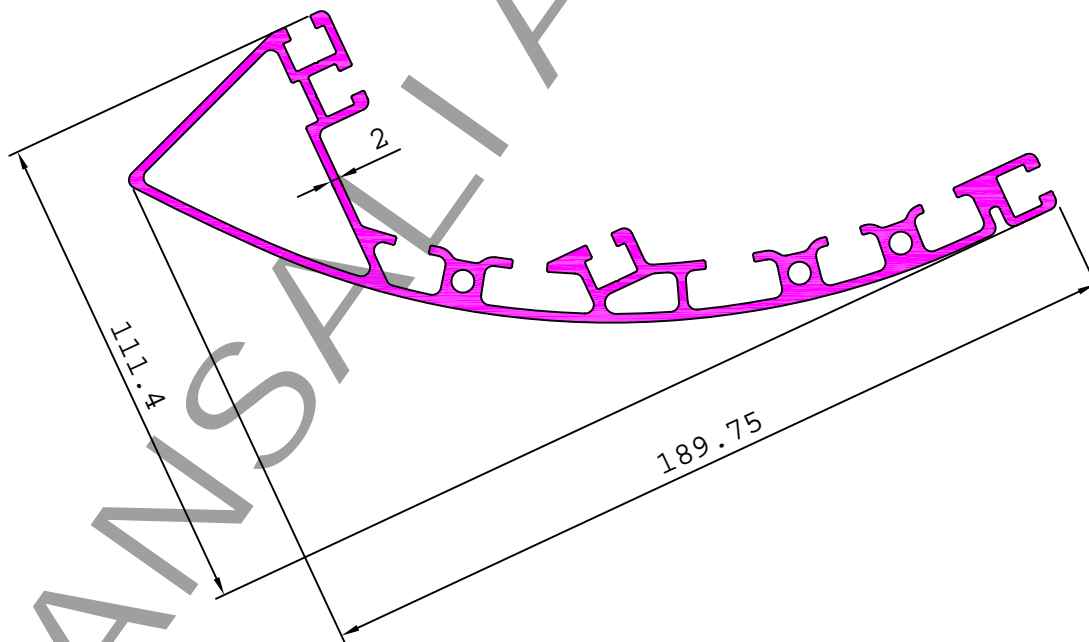

24483

0.198 kg/m

24484

0.201 kg/m

24485

0.137 kg/m

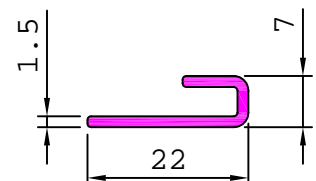
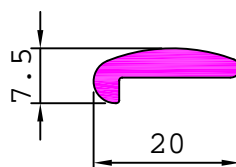
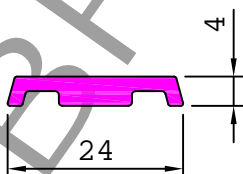



# TRANSPORT

## MISCELLANEOUS

24486

1.954 kg/m

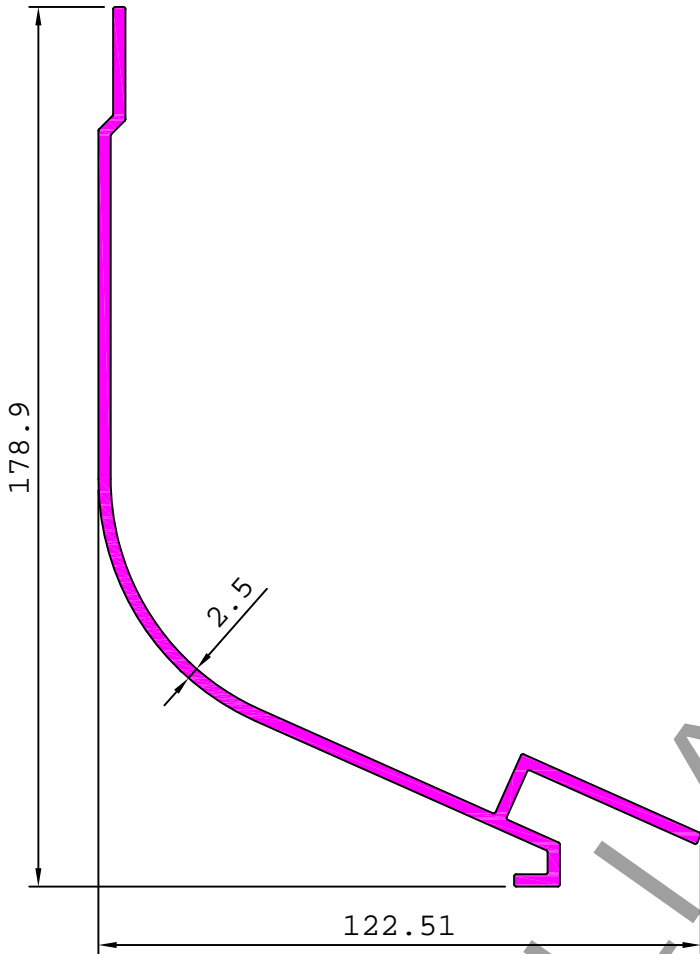

24488

1.064 kg/m

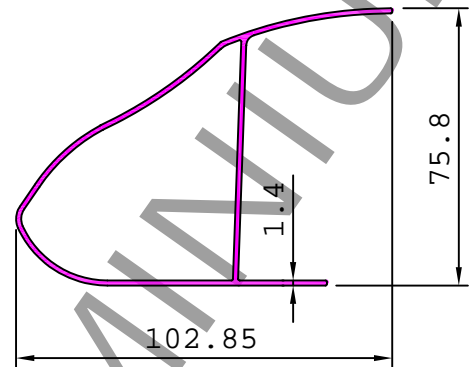

24489

1.328 kg/m

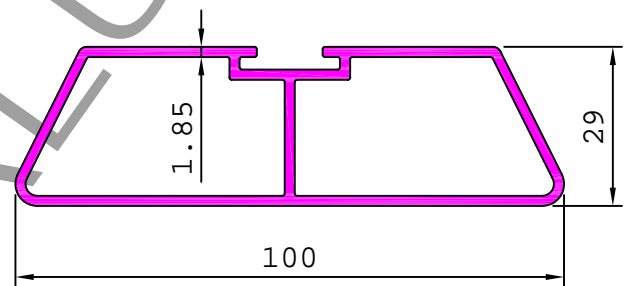

24487

1.509 kg/m

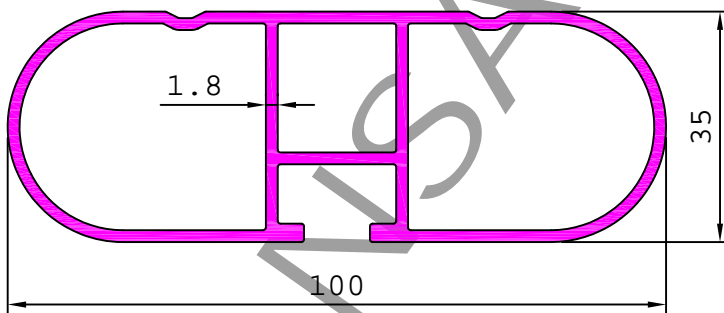

24491

0.270 kg/m

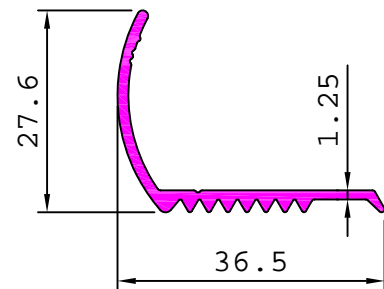

24490

1.410 kg/m

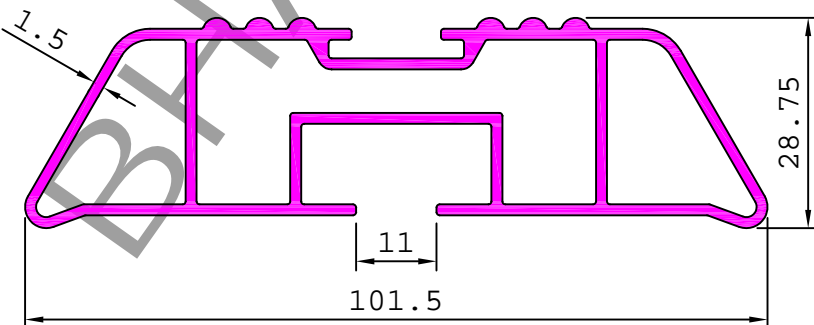

24492

1.558 kg/m

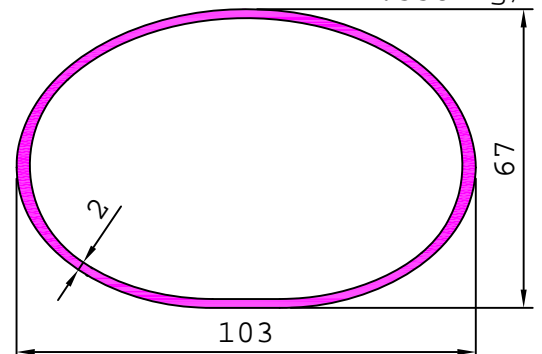

# TRANSPORT

## MISCELLANEOUS

24494

1.461 kg/m

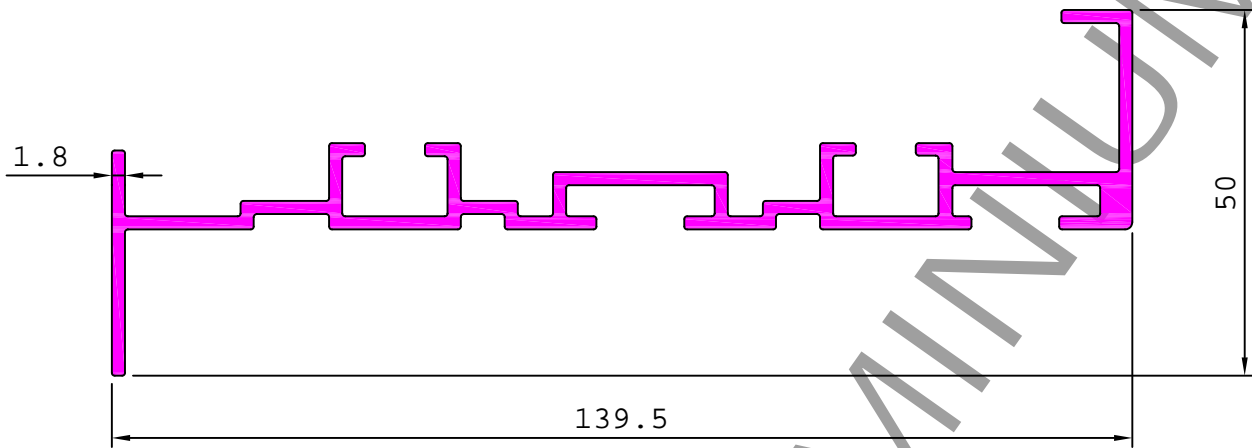

24495

0.147 kg/m

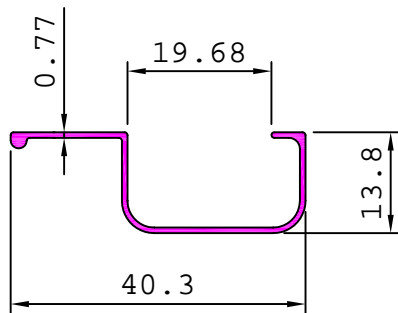

28097

3.204 kg/m

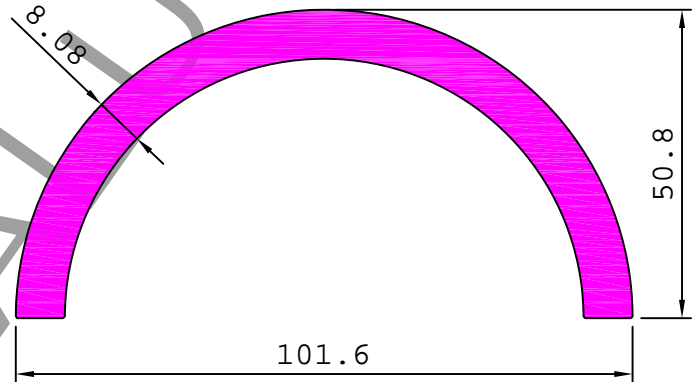

24496

1.140 kg/m

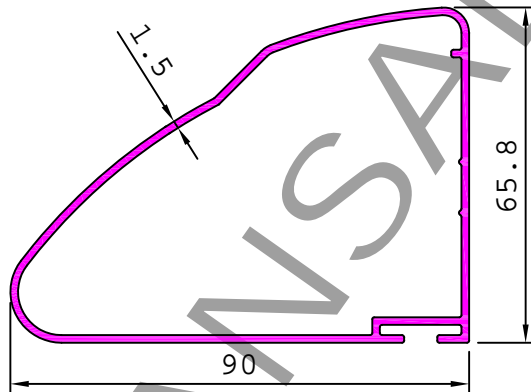

24497

0.587 kg/m

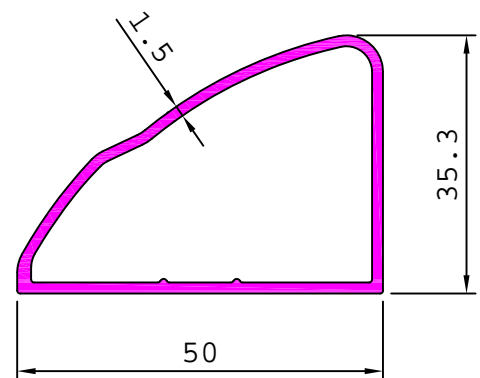

24498

1.171 kg/m

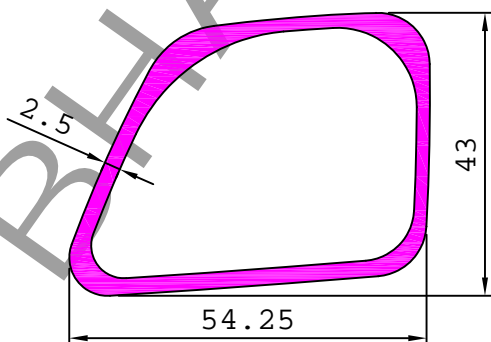

27944

1.341 kg/m

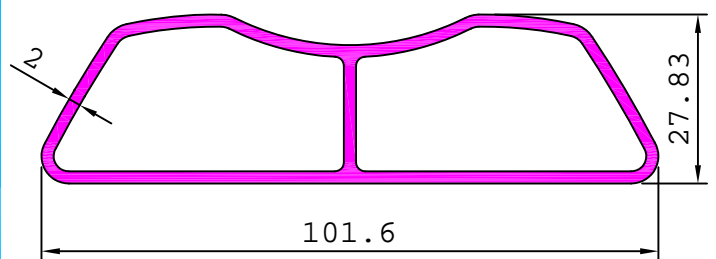

# TRANSPORT

## MISCELLANEOUS

S3918

1.016 kg/m

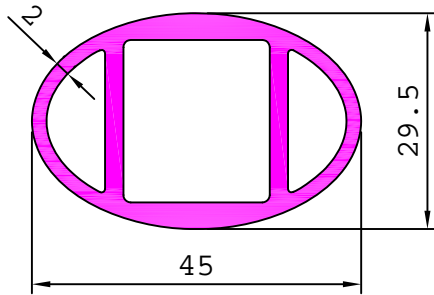

S4020

0.689 kg/m

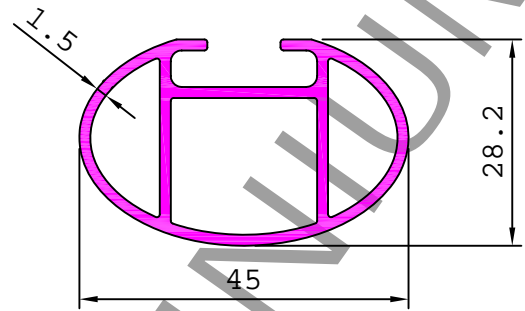

S3950

0.342 kg/m

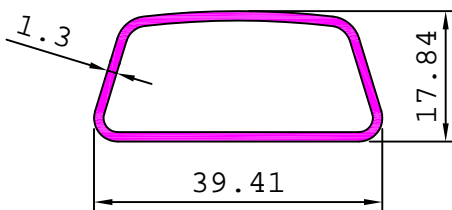

29512

1.175 kg/m

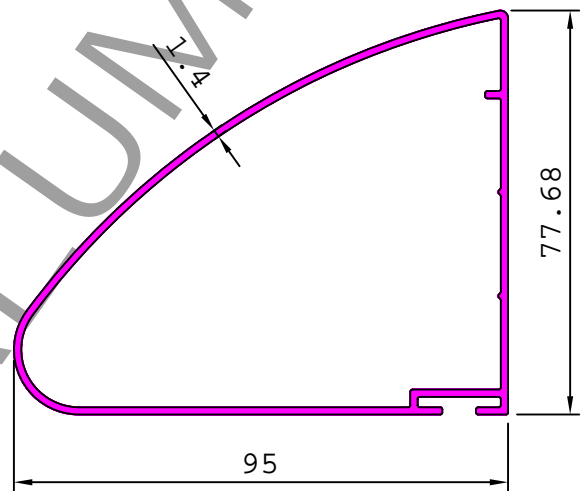

27594

1.337 kg/m

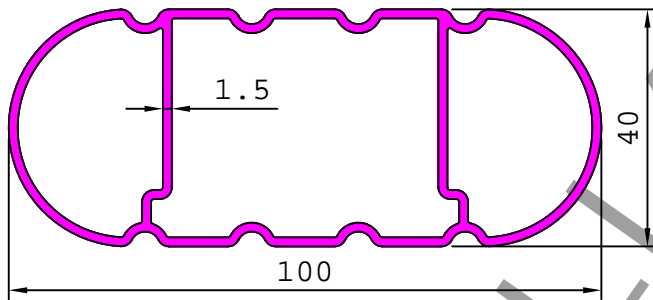

29450

0.744 kg/m

