

INDUSTRIAL

TEXTILE MACHINERY

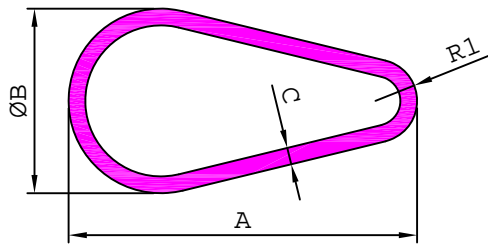

SL. No.	Section No.	A	ØB	C	R1	Weight kg/m
1	24701	38.25	27.94	1.27	8.41	0.343
2	24713	39.40	21.00	1.20	4.45	0.303

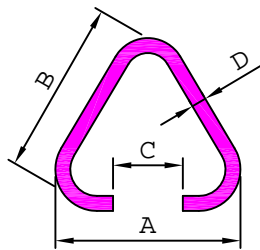

SL. No.	Section No.	A	B	C	D	Weight kg/m
1	24757	21.80	24.30	7.00	0.80	0.133
2	24715	24.80	24.80	8.00	1.10	0.192

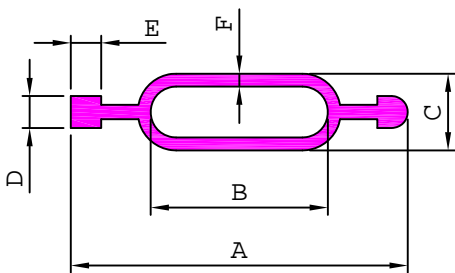

SL. No.	Section No.	A	B	C	D	E	F	Weight kg/m
1	24735	47.00	30.00	7.60	2.50	2.40	0.70	0.180
2	24732	60.00	41.00	8.40	3.50	2.65	0.85	0.287
3	24717	60.00	42.00	10.20	4.00	3.00	1.10	0.376

17516 0.121 kg/m

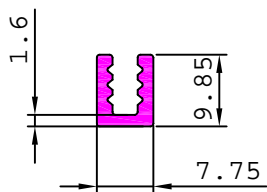

17525 0.084 kg/m

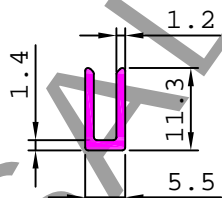

17526 0.080 kg/m

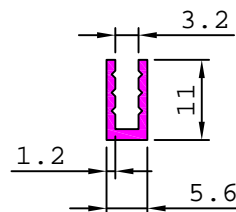

17567 0.124 kg/m

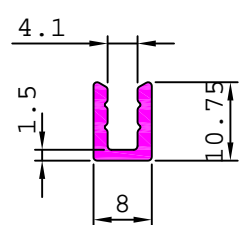

17568 0.194 kg/m

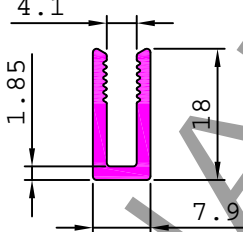

17577 0.140 kg/m

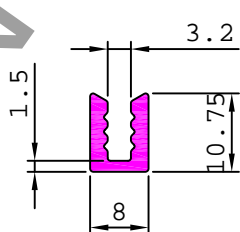

17620 0.133 kg/m

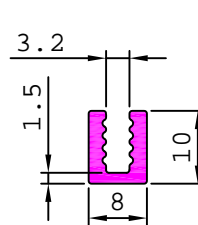

17623 0.107 kg/m

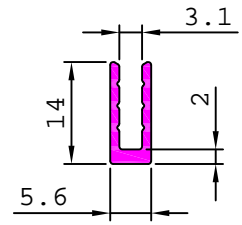

17639 0.120 kg/m

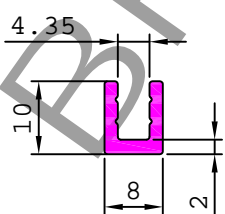

24817 0.108 kg/m

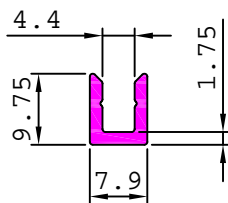

24818 0.186 kg/m

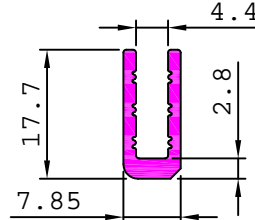

24826 0.144 kg/m

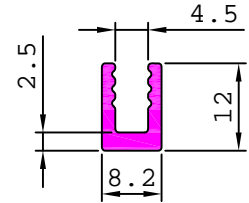

INDUSTRIAL

TEXTILE MACHINERY

24836 0.219 kg/m

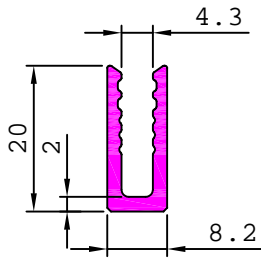

17674 0.306 kg/m

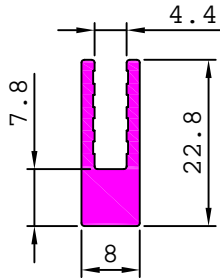

17687 0.223 kg/m

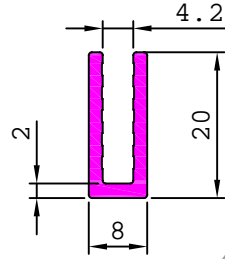

24794 0.327 kg/m

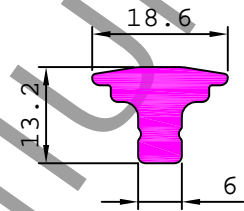

S3670 0.206 kg/m

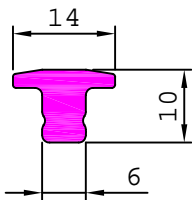

24734 0.534 kg/m

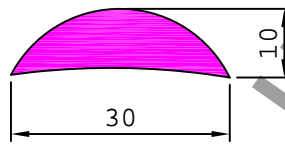

24736 0.772 kg/m

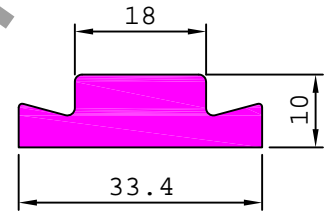

24739 1.224 kg/m

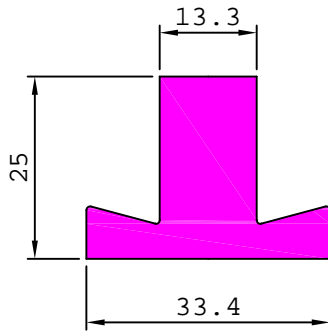

24746 0.724 kg/m

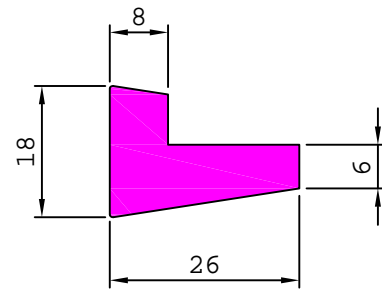

24759 0.609 kg/m

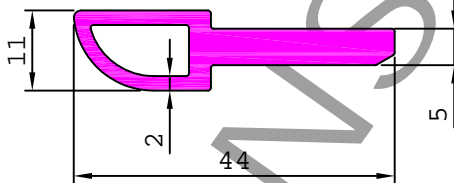

24790 0.538 kg/m

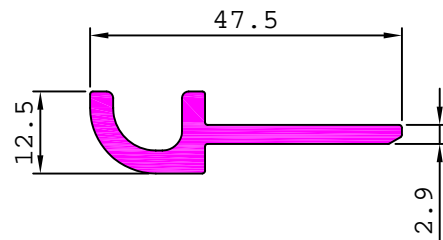

24830 0.431 kg/m

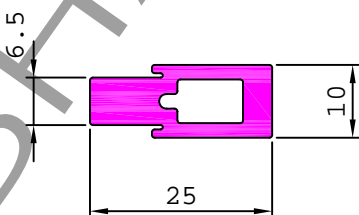

24786 1.357 kg/m

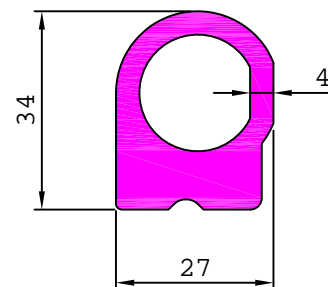

INDUSTRIAL

TEXTILE MACHINERY

24745 1.986 kg/m

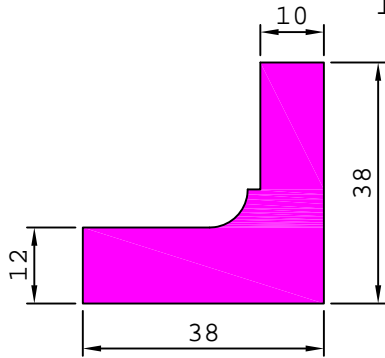

24747 3.511 kg/m

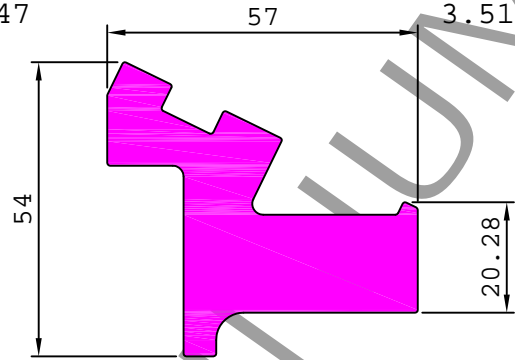

24777 2.800 kg/m

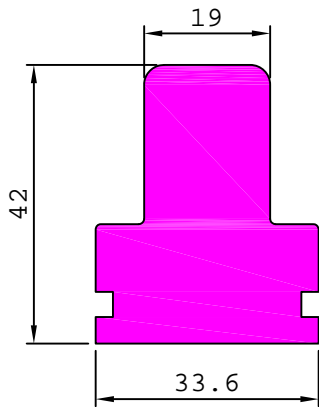

24781 2.132 kg/m

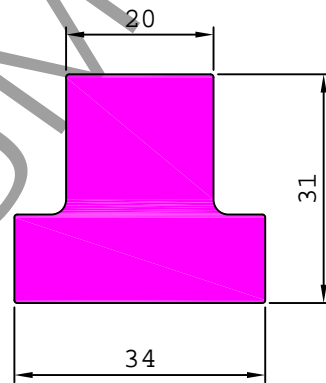

24737 2.434 kg/m

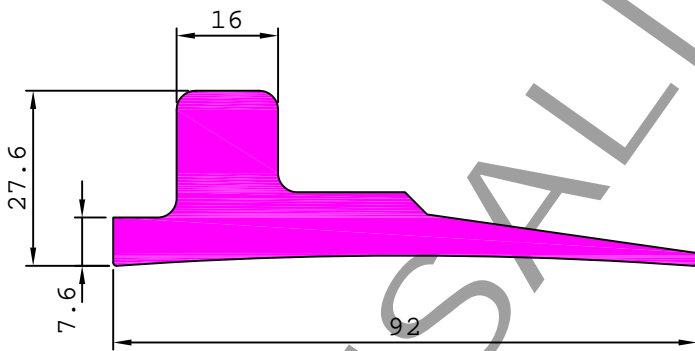

24740 5.797 kg/m

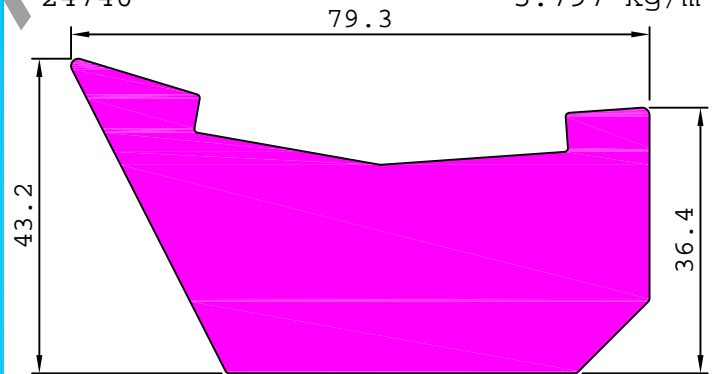

24769 12.824 kg/m

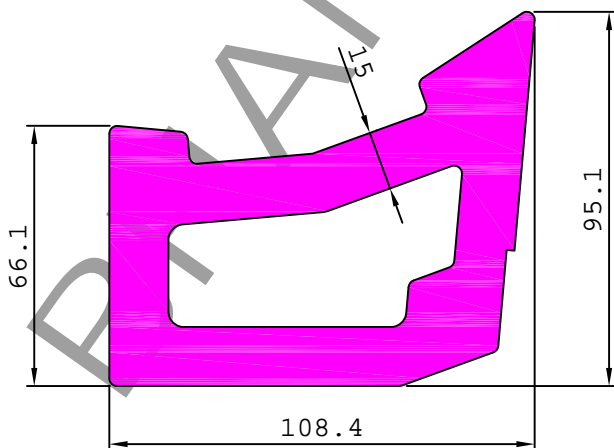

24770 9.505 kg/m

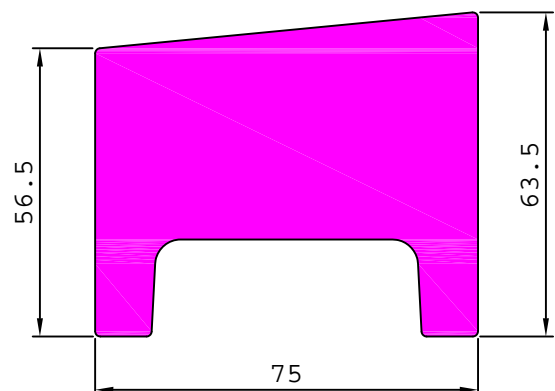

INDUSTRIAL

TEXTILE MACHINERY

24774 102.6 5.946 kg/m

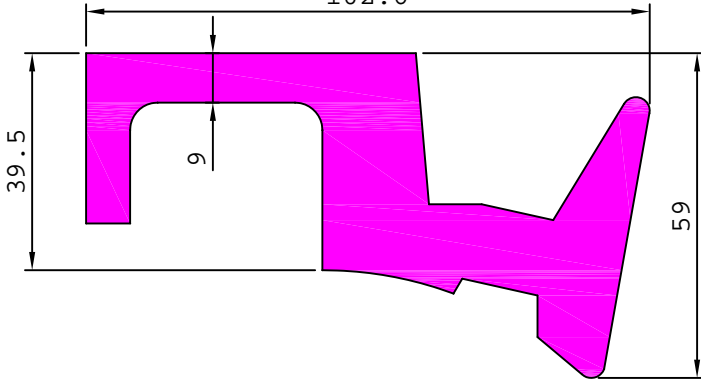

24787 2.143 kg/m

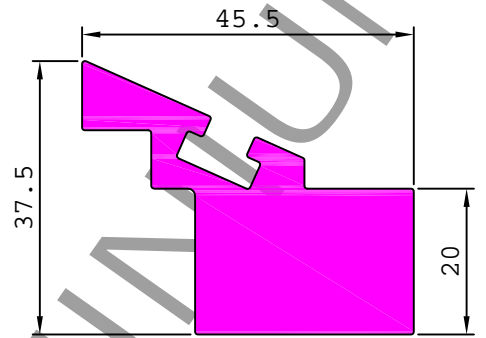

24788 1.907 kg/m

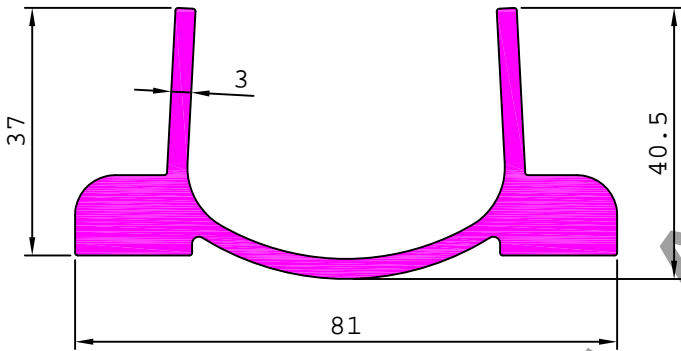

24799 5.042 kg/m

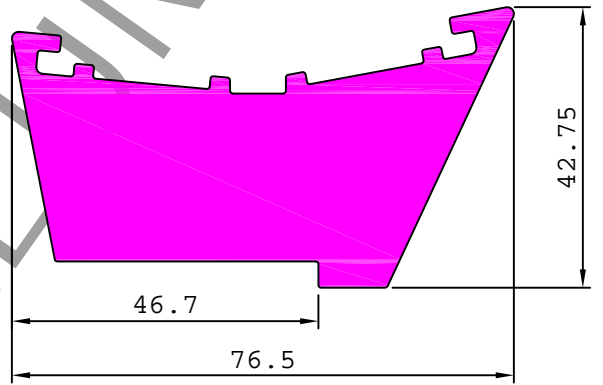

24801 76.8 7.022 kg/m

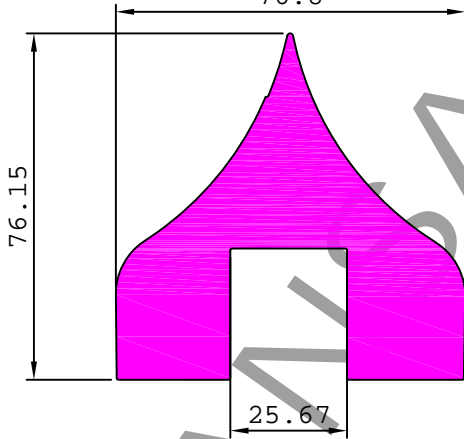

24828 5.523 kg/m

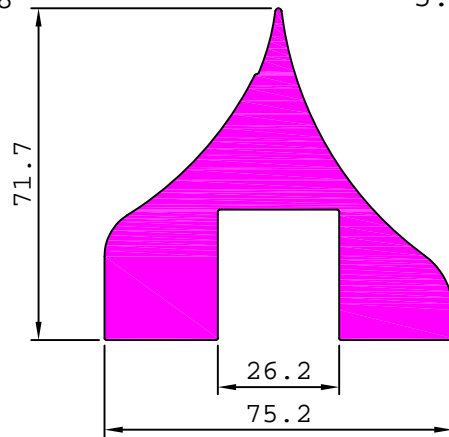

24823 4.265 kg/m

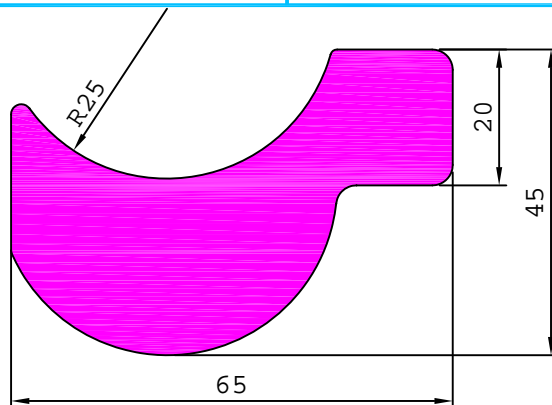

INDUSTRIAL

TEXTILE MACHINERY

S3530 5.541 kg/m

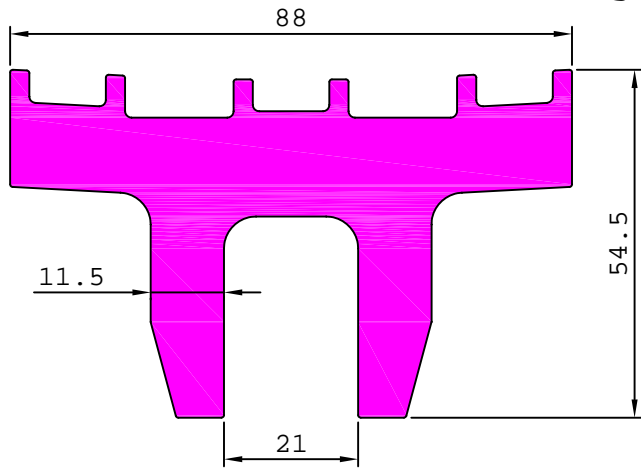

S3531 4.152 kg/m

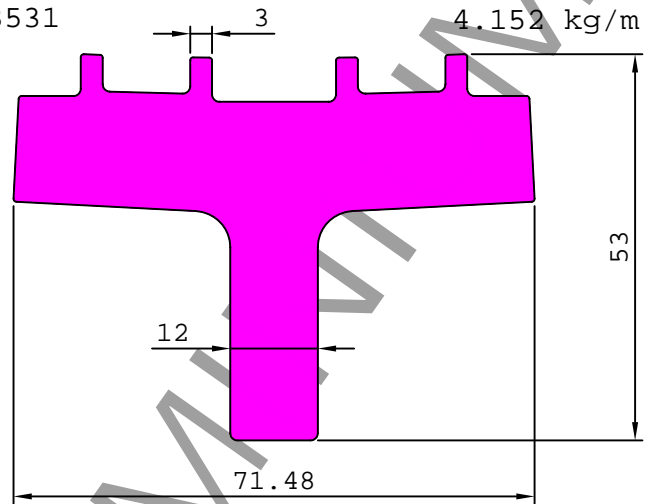

24776 10.430 kg/m

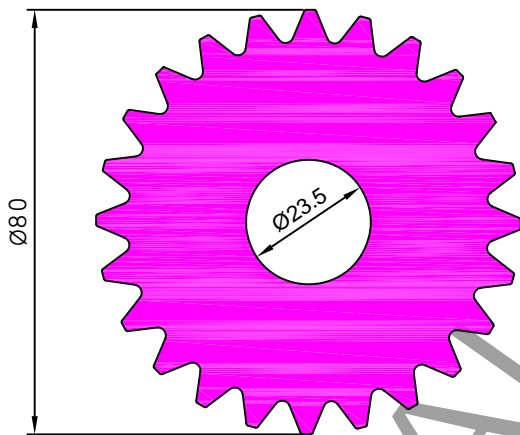

24768 11.712 kg/m

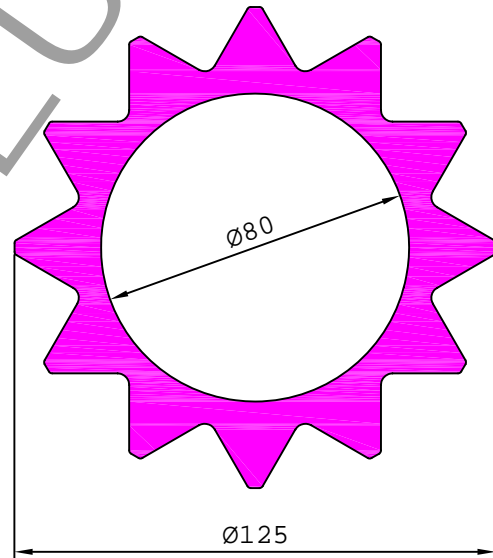

24824 6.306 kg/m

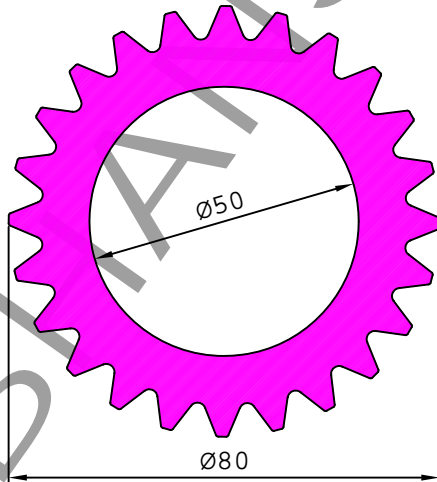

24809 2.332 kg/m

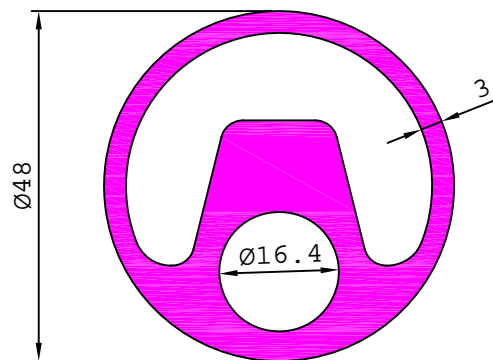

INDUSTRIAL

TEXTILE MACHINERY

24763

8.057 kg/m

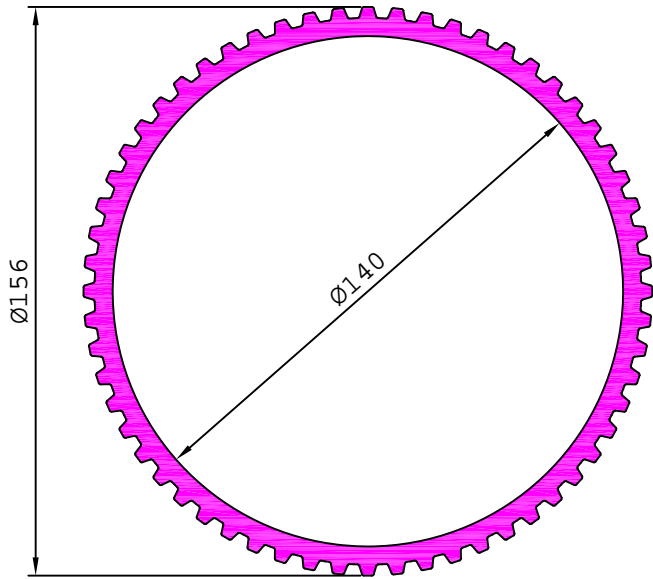

24764

7.803 kg/m

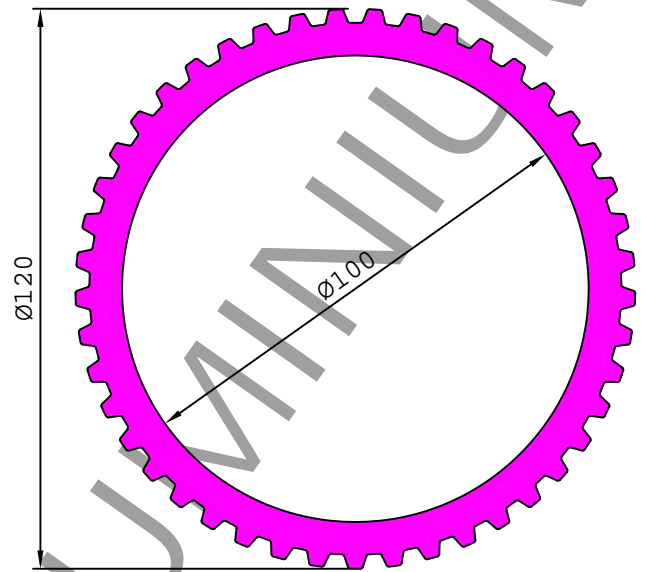

24762

1.479 kg/m

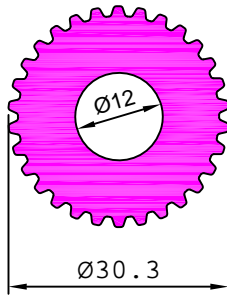

24834

0.822 kg/m

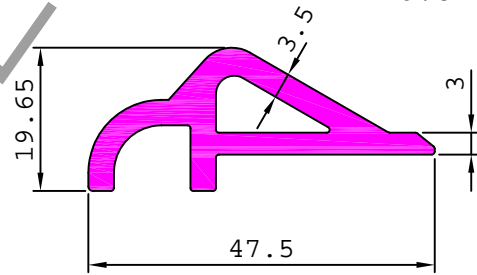

24791

4.106 kg/m

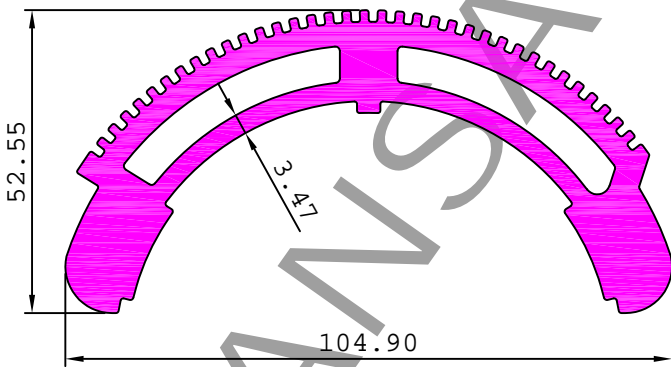

24795

3.695 kg/m

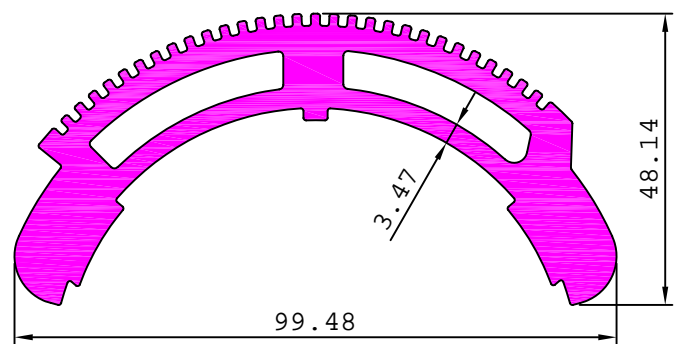

24792

1.880 kg/m

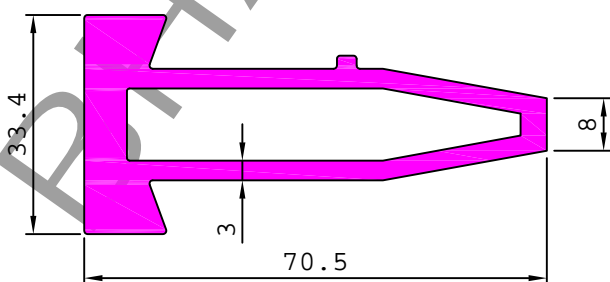

24731

2.223 kg/m

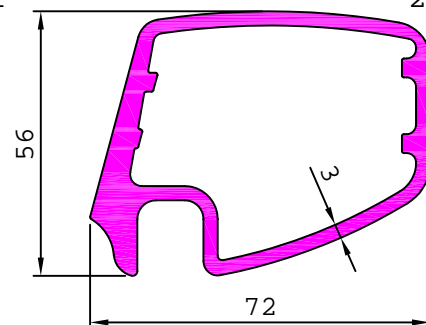

INDUSTRIAL

TEXTILE MACHINERY

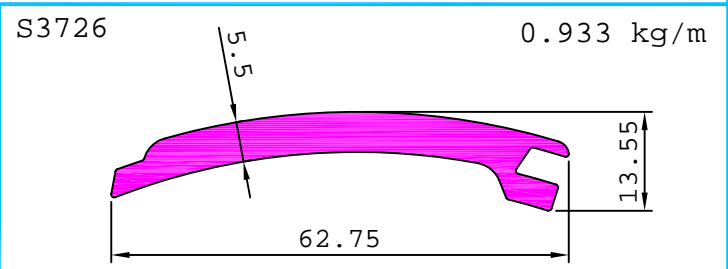
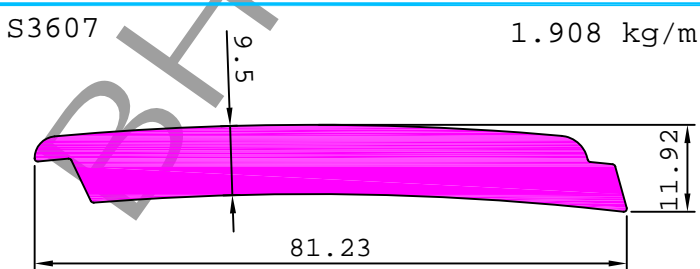
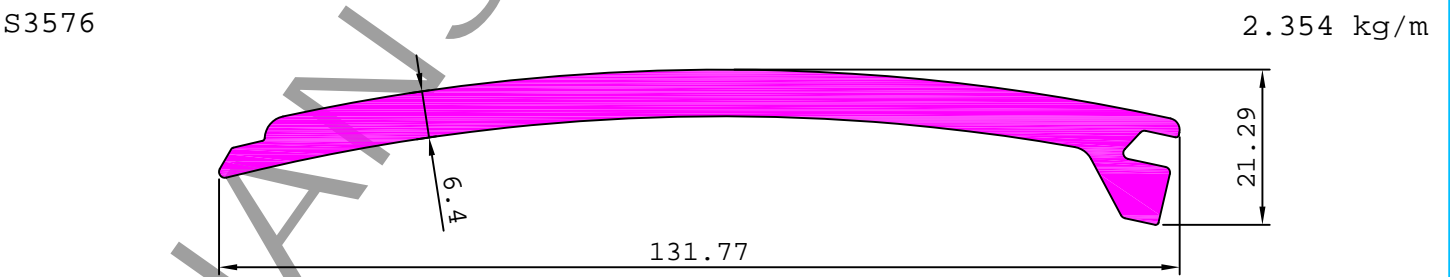
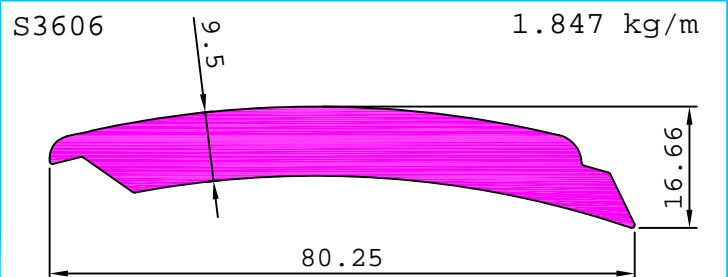
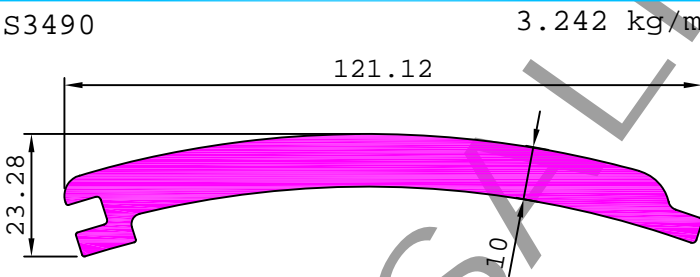
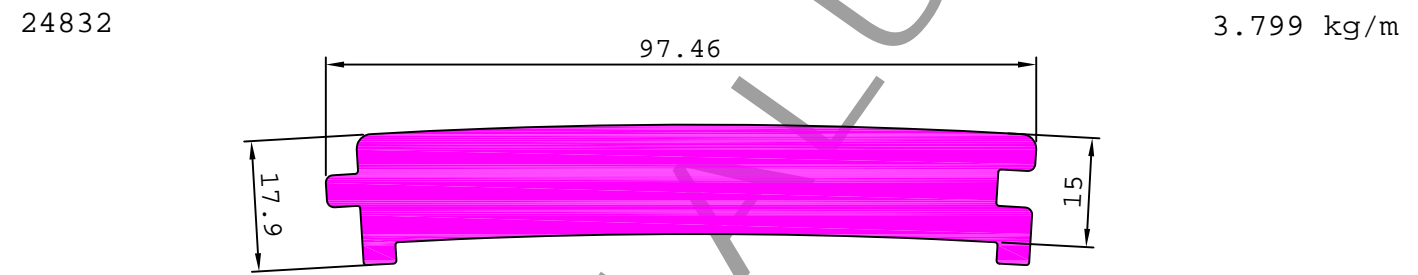
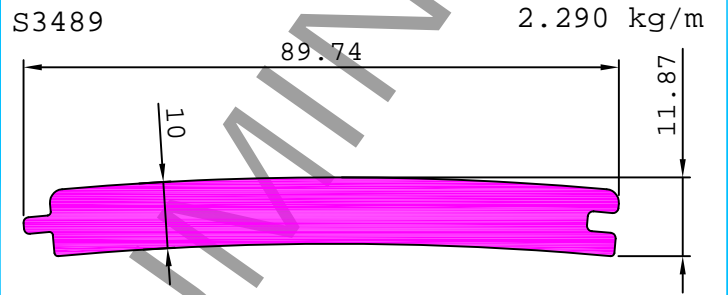
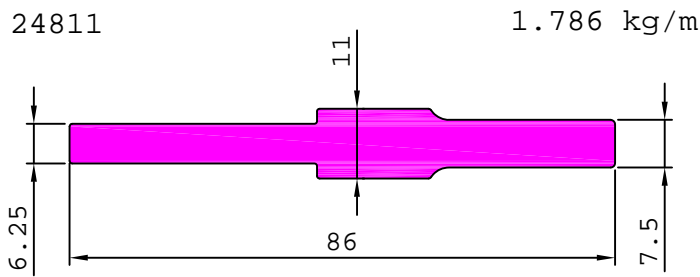
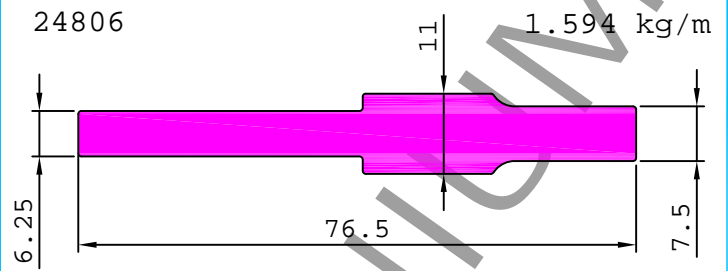
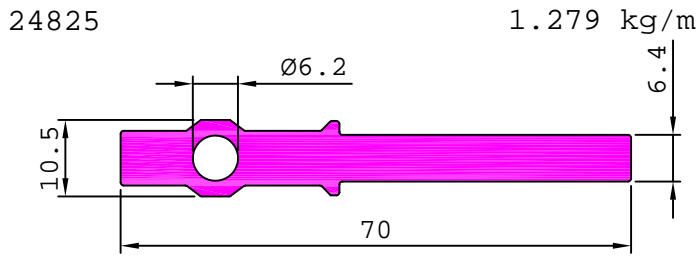

INDUSTRIAL

TEXTILE MACHINERY

<p>24805 1.043 kg/m</p>	<p>24816 1.042 kg/m</p>	
<p>24751 0.891 kg/m</p>	<p>24741 0.547 kg/m</p>	
<p>24743 0.754 kg/m</p>	<p>24755 0.255 kg/m</p>	
<p>24771 0.226 kg/m</p>	<p>24775 0.259 kg/m</p>	<p>24780 0.453 kg/m</p>
<p>24793 0.303 kg/m</p>	<p>24804 0.807 kg/m</p>	
<p>24814 0.556 kg/m</p>	<p>24815 0.231 kg/m</p>	<p>24810 0.245 kg/m</p>

INDUSTRIAL

TEXTILE MACHINERY

24821 0.326 kg/m

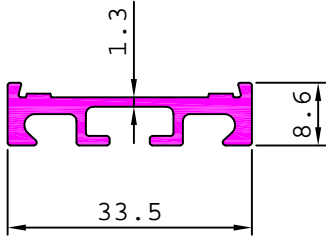

24822 0.394 kg/m

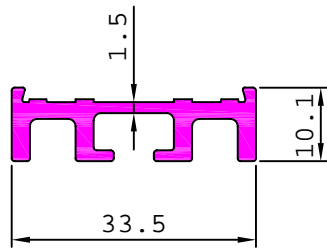

24827 0.379 kg/m

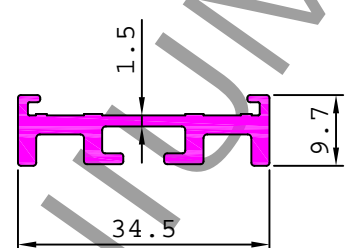

24813 0.825 kg/m

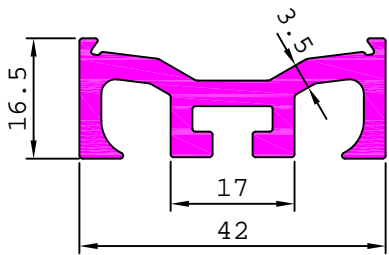

S3673 0.380 kg/m

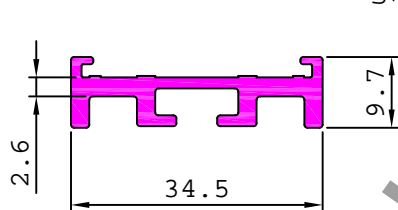

S3678 0.502 kg/m

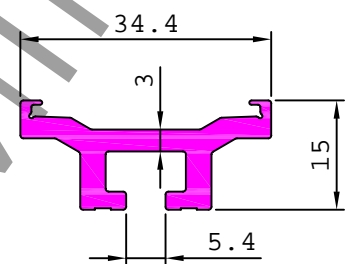

24796

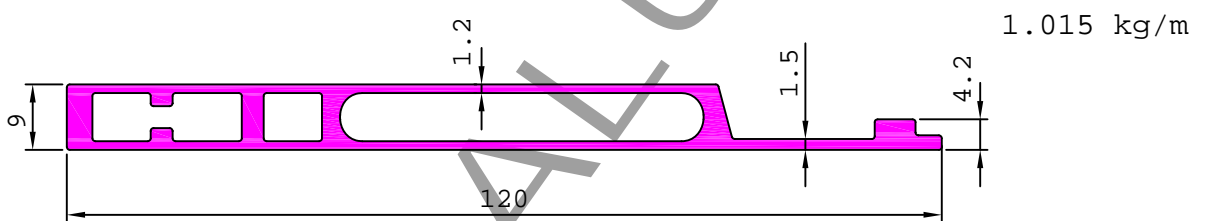

24797

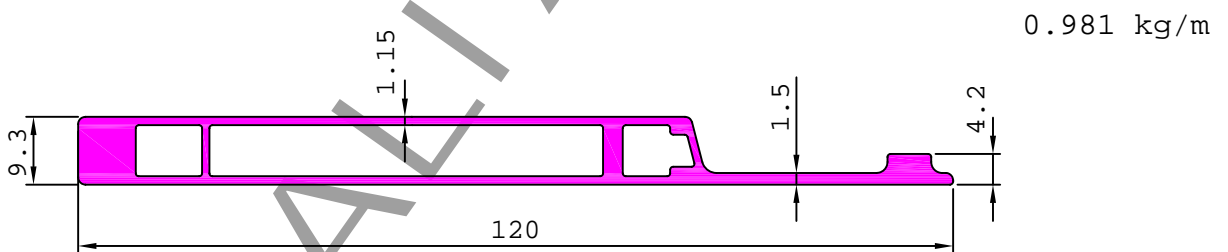

24802 0.908 kg/m

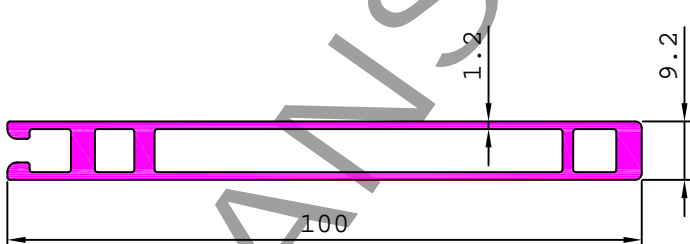

S3360 0.855 kg/m

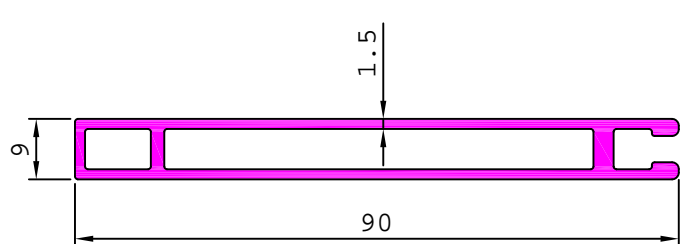

24807

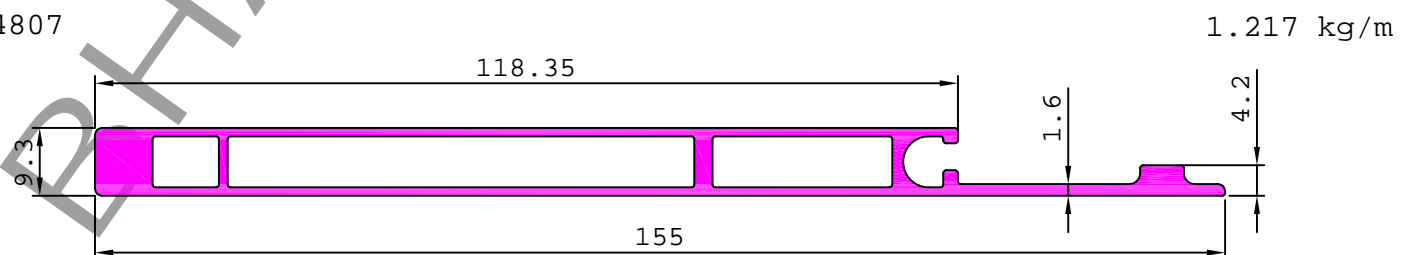

INDUSTRIAL

TEXTILE MACHINERY

24808

1.017 kg/m

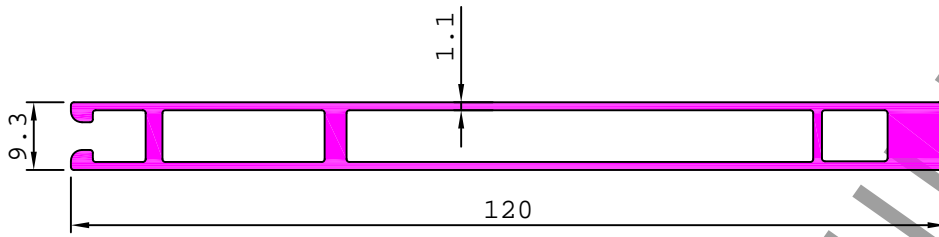

24812

1.038 kg/m

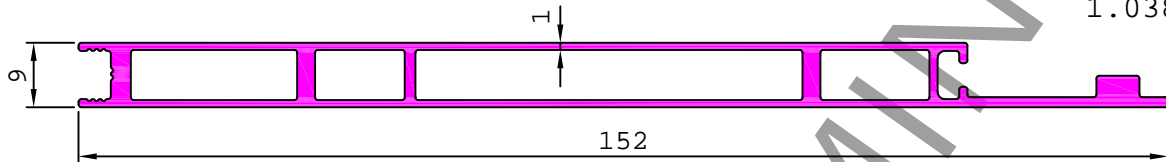

24819

1.252 kg/m

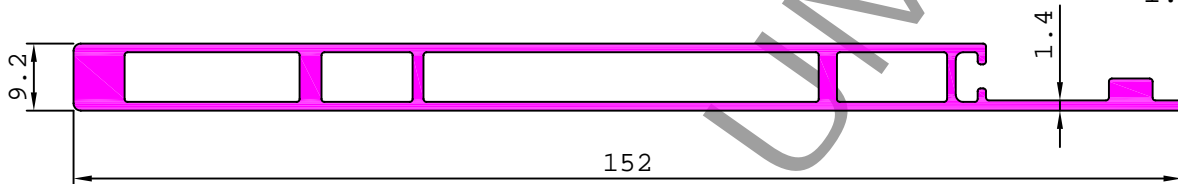

S3493

1.190 kg/m

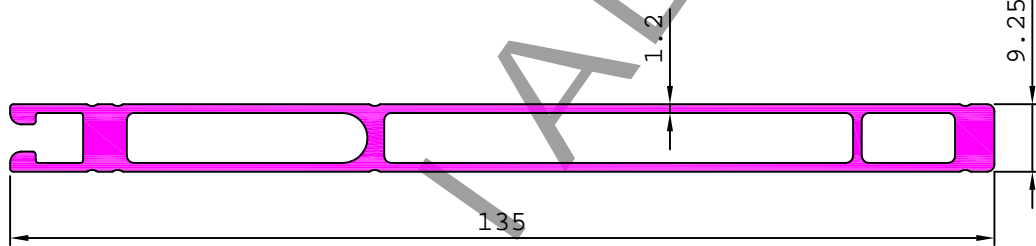

24798

2.722 kg/m

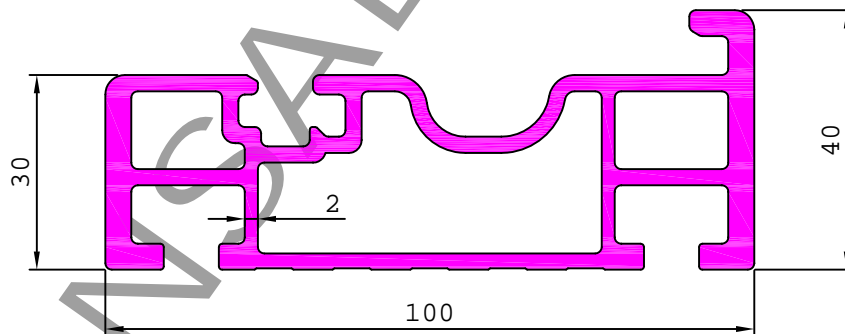

24835

3.063 kg/m

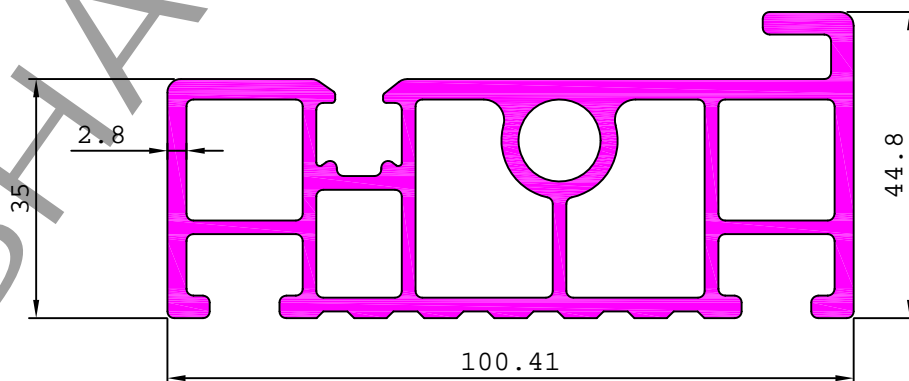

INDUSTRIAL

TEXTILE MACHINERY

24820

2.692 kg/m

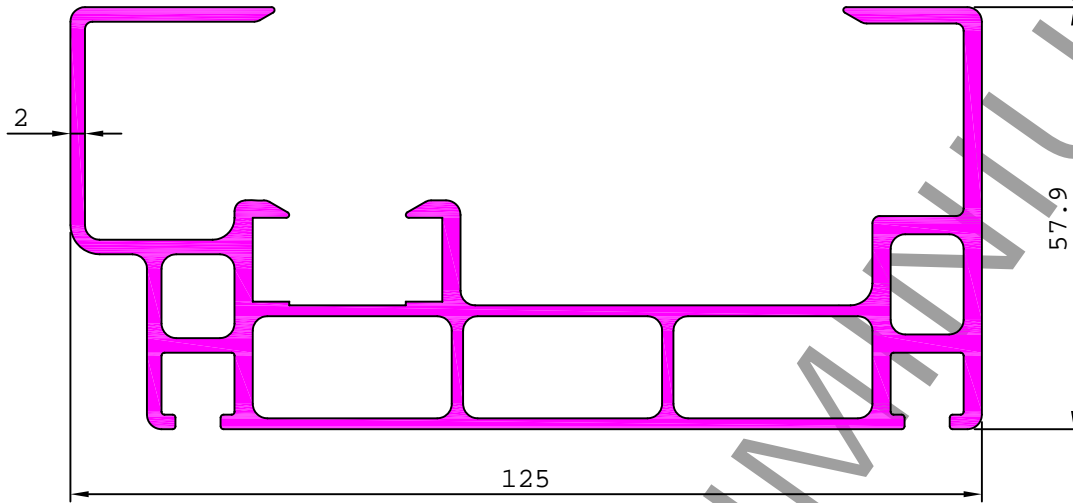

24829

2.691 kg/m

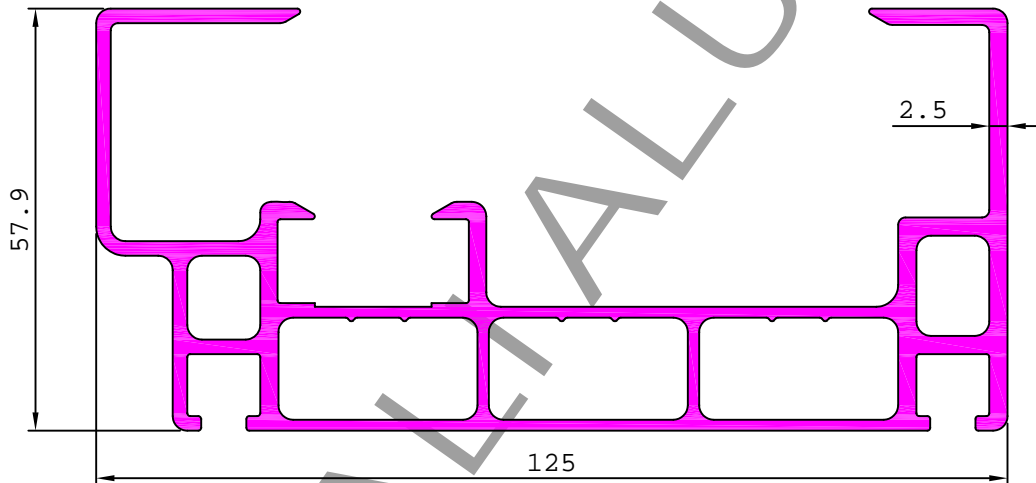

24831

0.838 kg/m

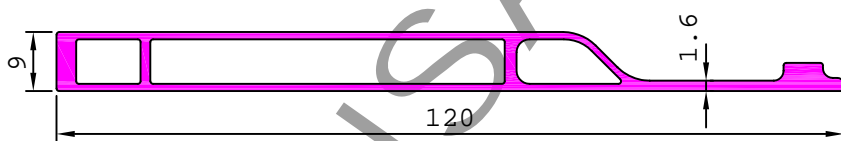

24837

0.152 kg/m

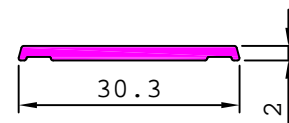

24838

0.119 kg/m

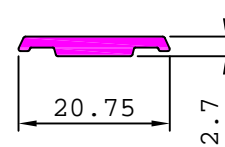

24833

2.099 kg/m

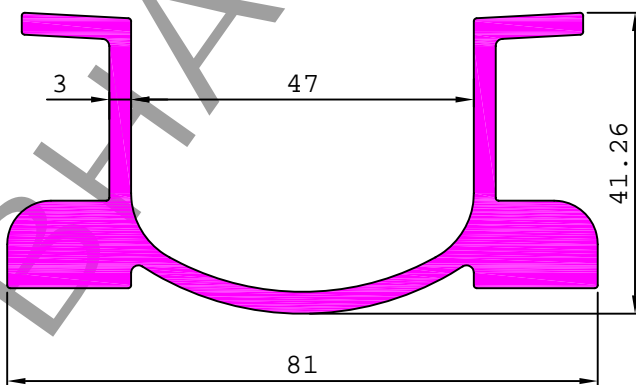

24839

0.124 kg/m

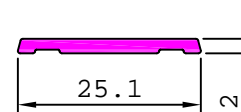

24842

0.085 kg/m

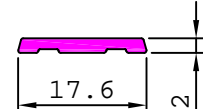

INDUSTRIAL

TEXTILE MACHINERY

24840 1.172 kg/m

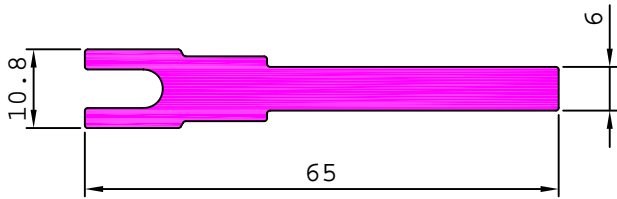

24841 1.427 kg/m

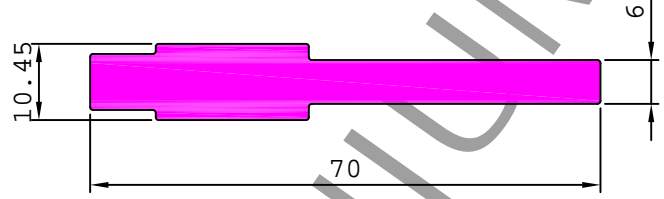

24843 2.912 kg/m

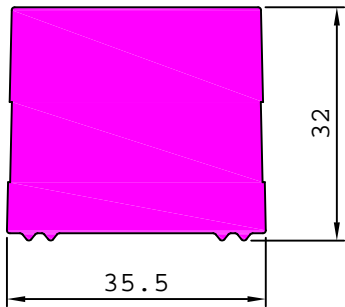

24844 2.743 kg/m

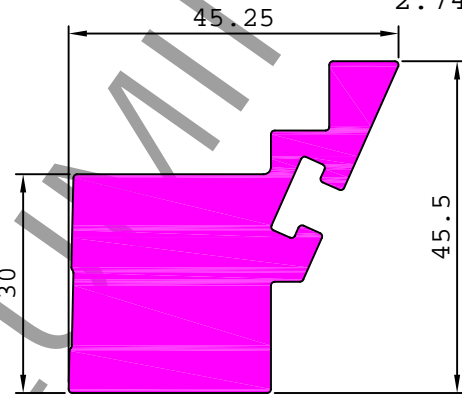

24845 3.574 kg/m

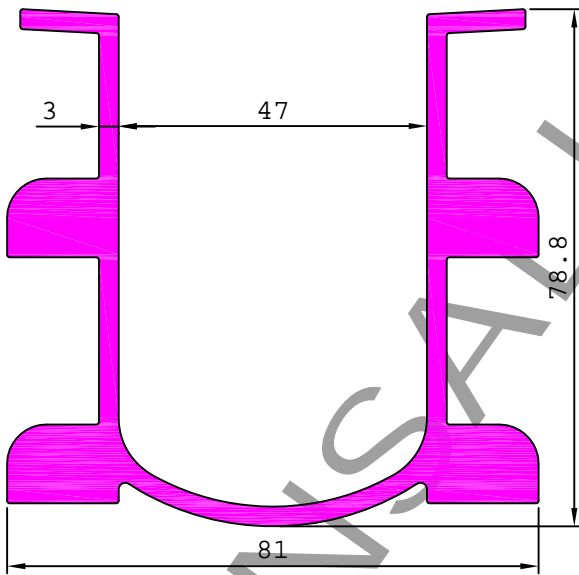

24846 1.129 kg/m

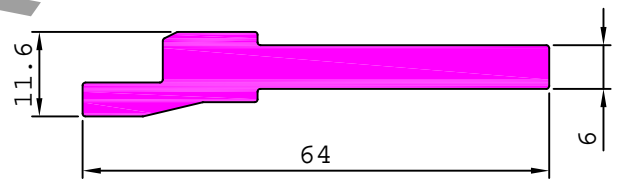

S3732 2.448 kg/m

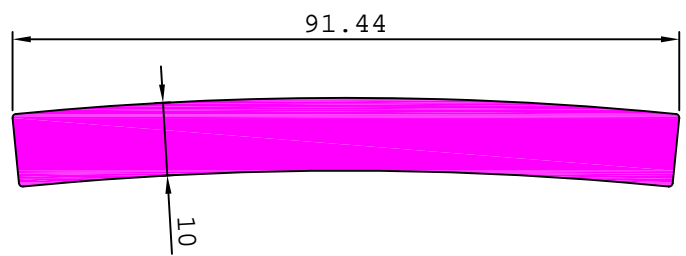

S3795 4.094 kg/m

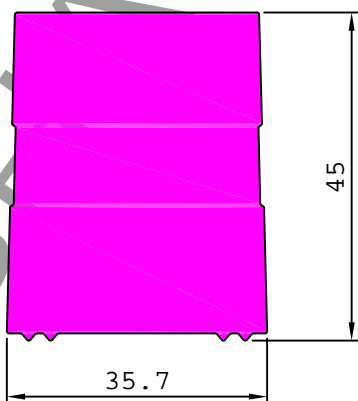

S3854 2.248 kg/m

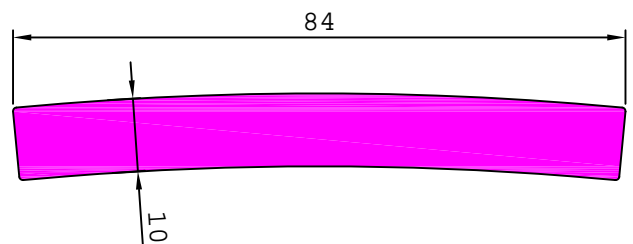

INDUSTRIAL

TEXTILE MACHINERY

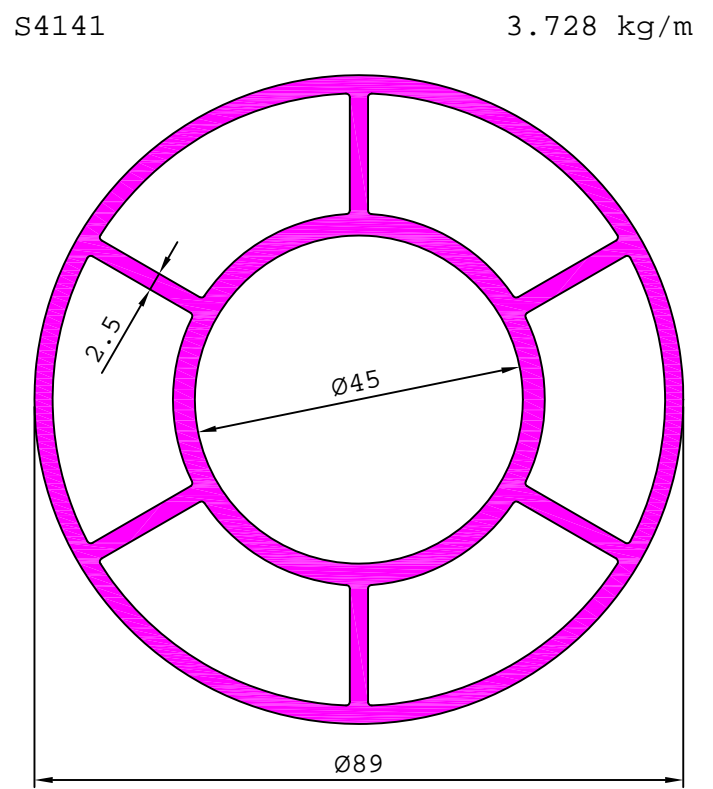
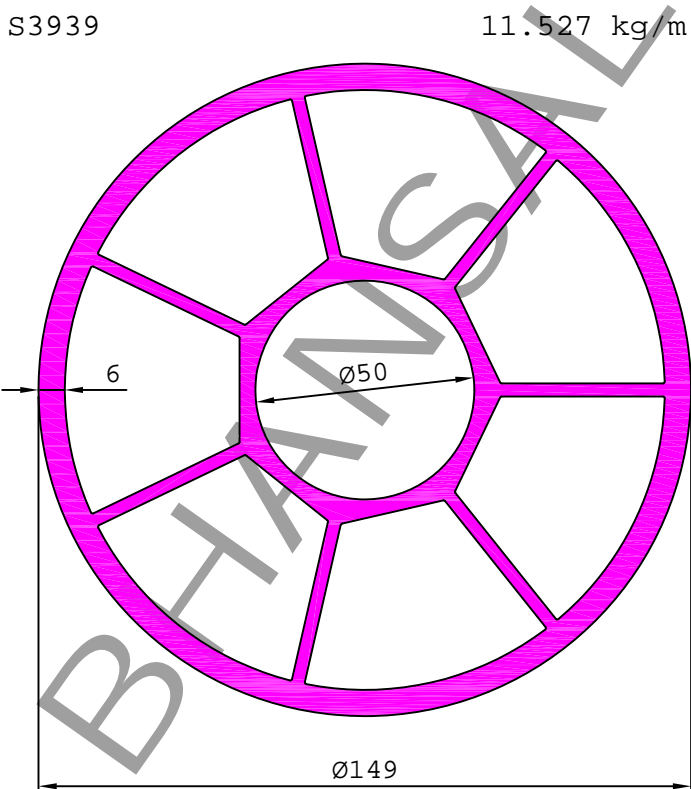
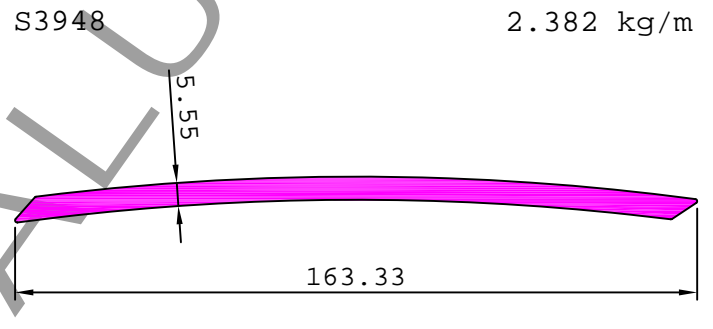
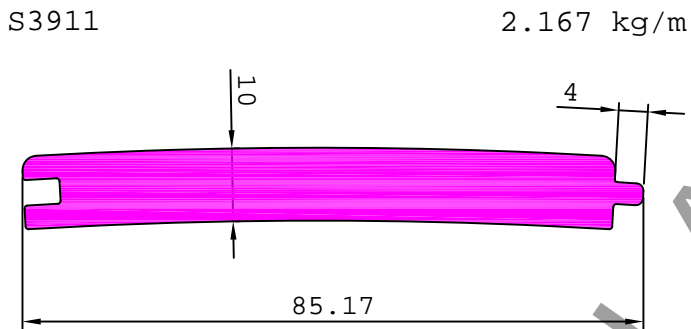
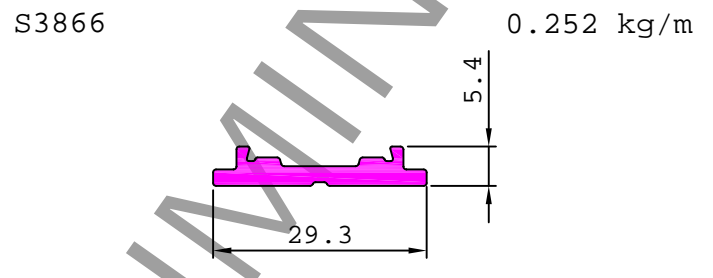
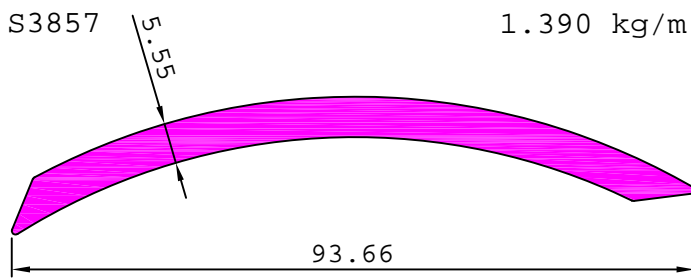
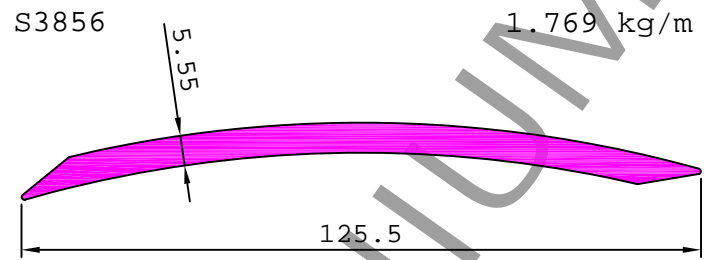
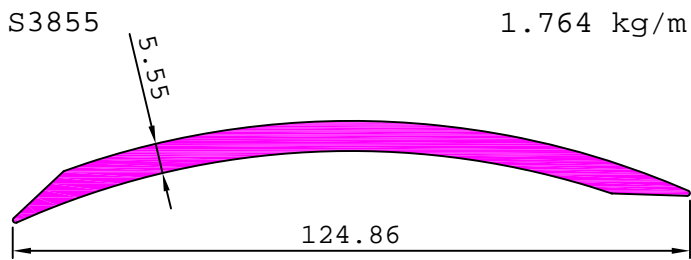

INDUSTRIAL

TEXTILE MACHINERY

S3949 1.046 kg/m

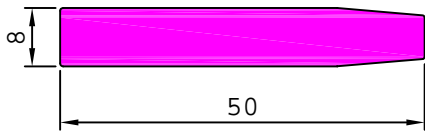

S4017 0.937 kg/m

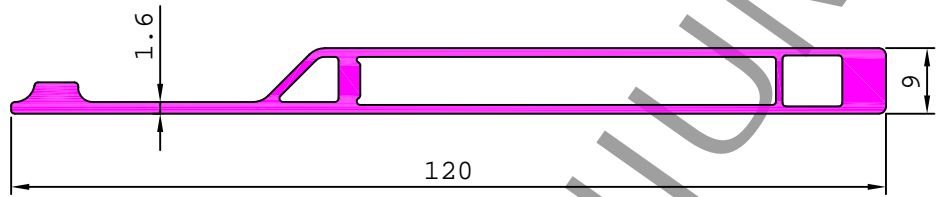

S3983 0.426 kg/m

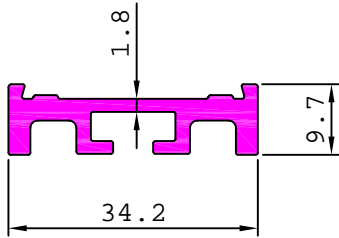

S3984 0.613 kg/m

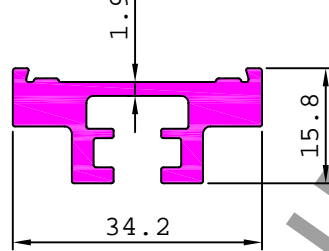

S3985 0.610 kg/m

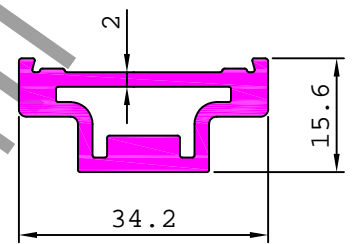

S4043 1.200 kg/m

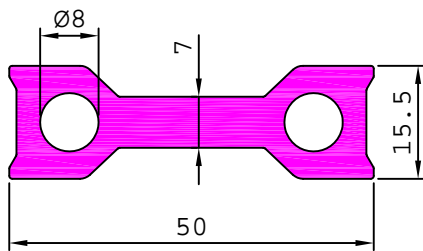

S4121 2.711 kg/m

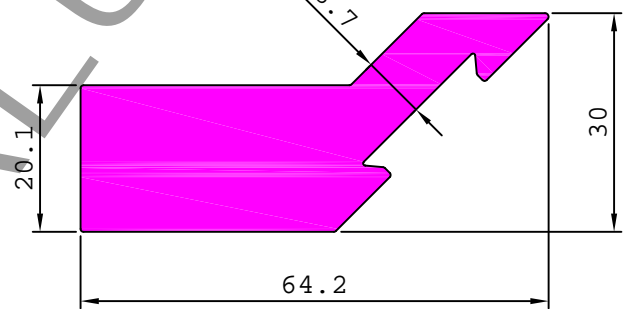

S4145 0.560 kg/m

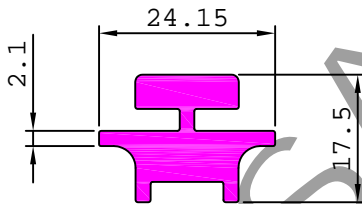

27359 0.830 kg/m

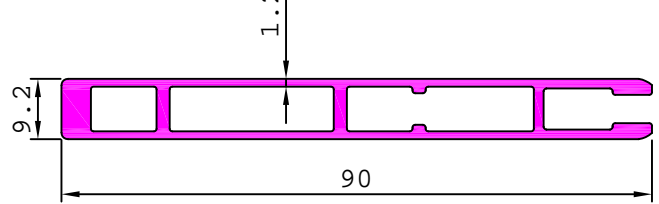

27622 0.946 kg/m

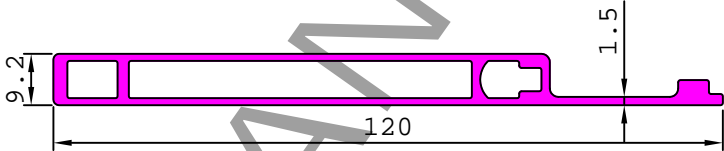

27989 2.204 kg/m

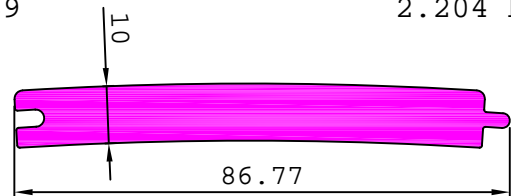

27665 0.780 kg/m

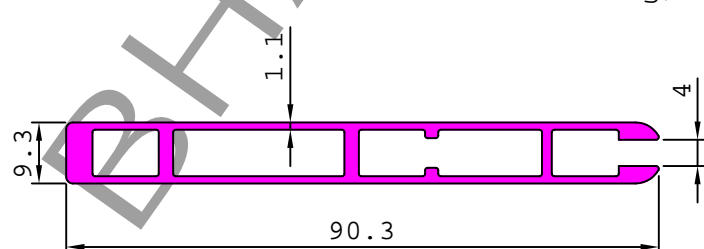

27975 3.317 kg/m

