

INDUSTRIAL

ELECTRICALS

25052

1.932 kg/m

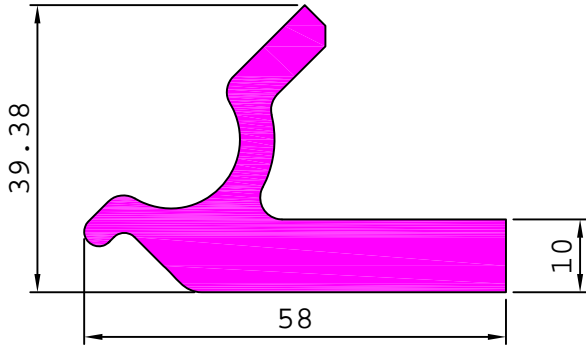

25059

0.371 kg/m

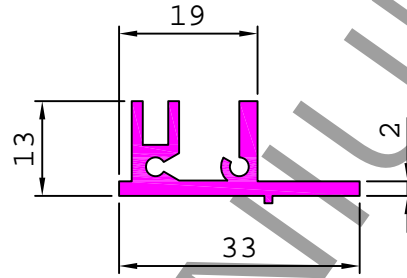

25060

0.336 kg/m

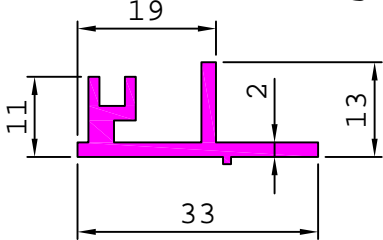

25063

0.129 kg/m

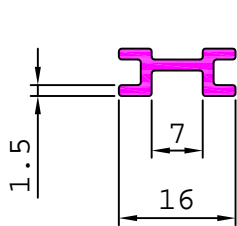

25065

0.708 kg/m

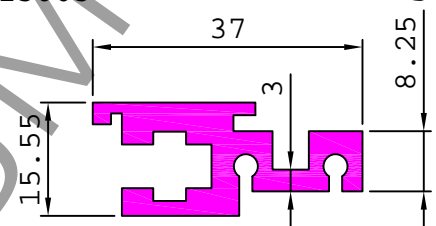

25064

1.094 kg/m

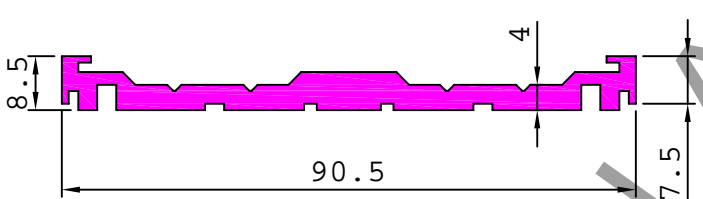

25069

0.798 kg/m

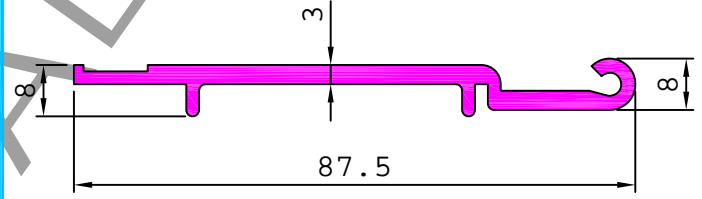

25075

0.800 kg/m

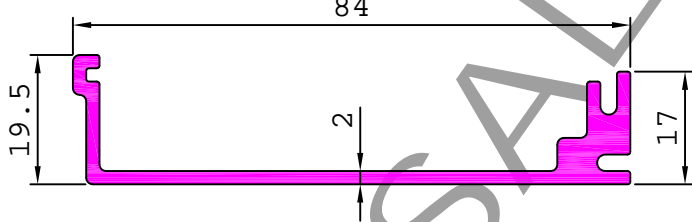

25081

0.358 kg/m

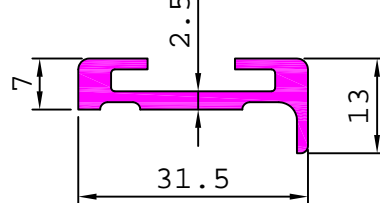

25090

1.363 kg/m

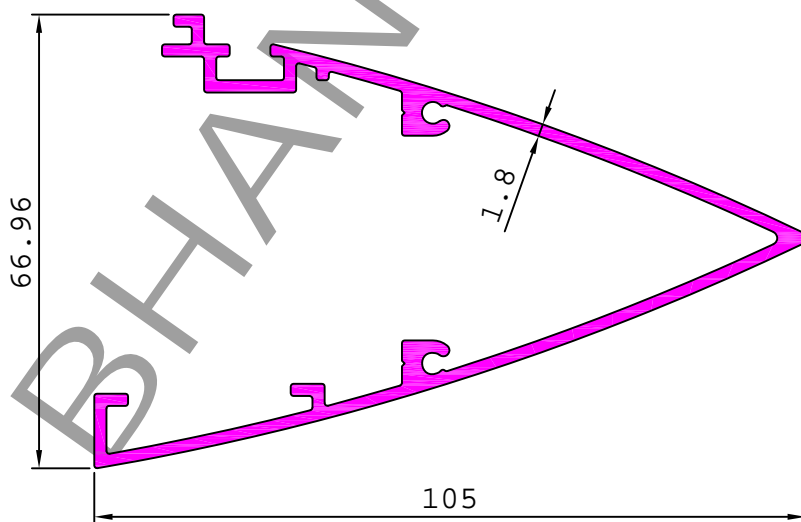

25080

1.161 kg/m

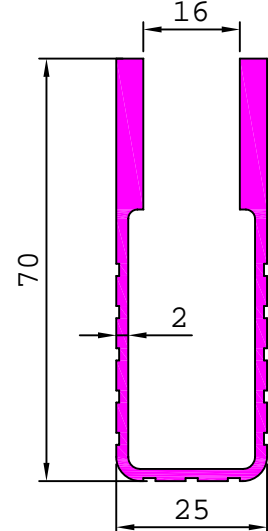

INDUSTRIAL

ELECTRICALS

25091

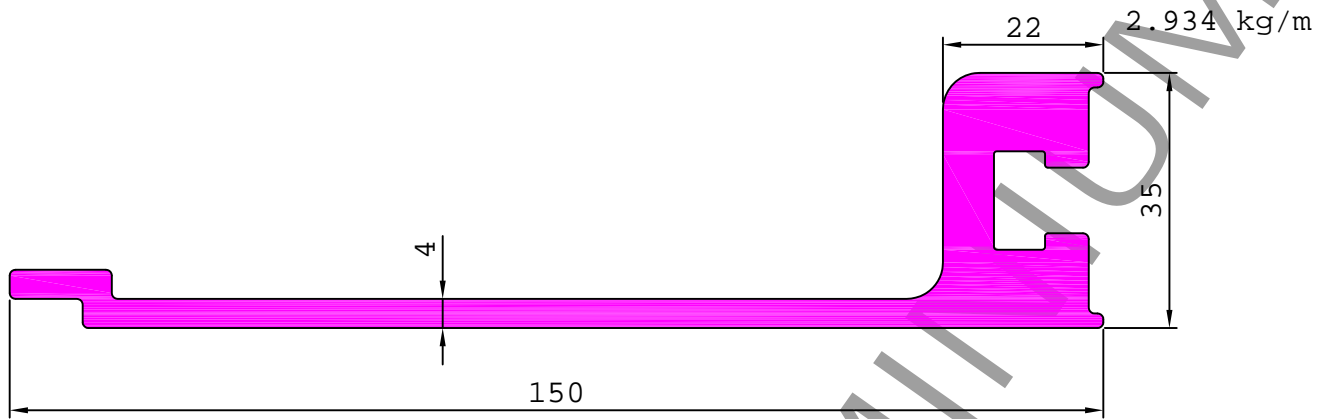

25092

1.480 kg/m

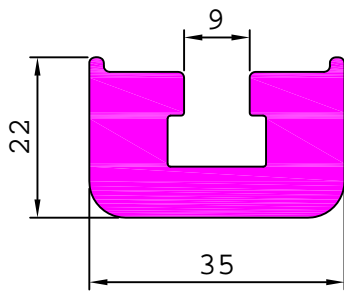

25093

4.836 kg/m

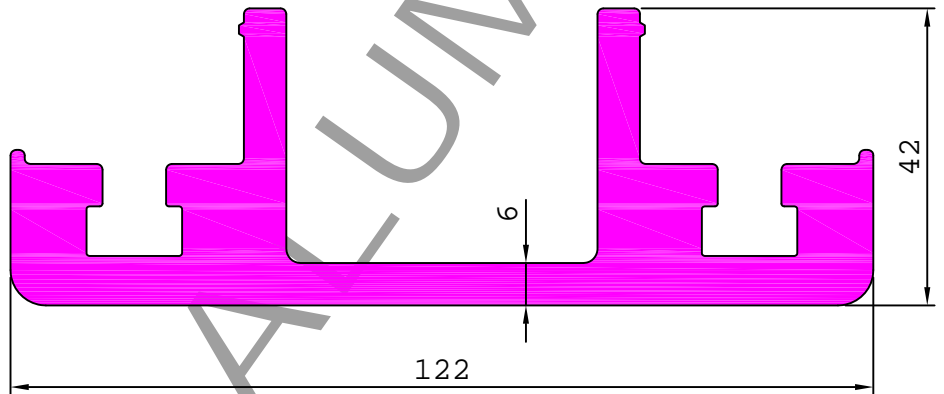

25095

5.913 kg/m

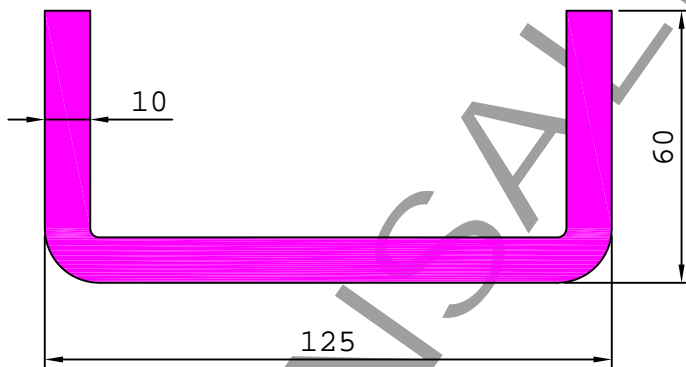

25096

0.199 kg/m

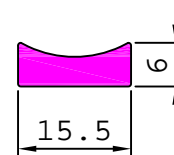

25097

0.560 kg/m

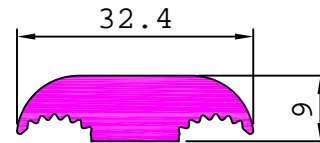

25098

1.341 kg/m

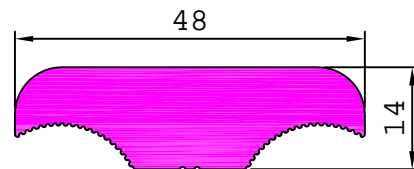

25099

0.881 kg/m

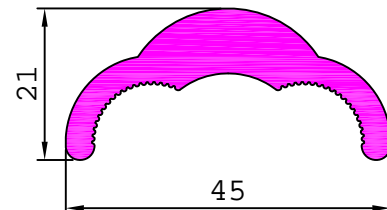

25100

2.325 kg/m

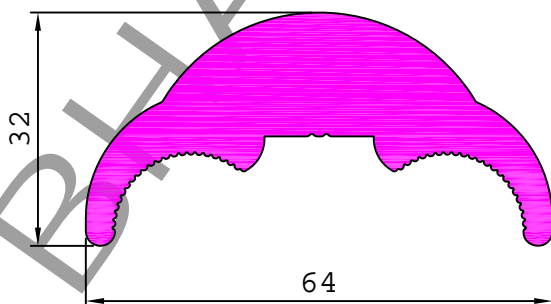

INDUSTRIAL

ELECTRICALS

25103

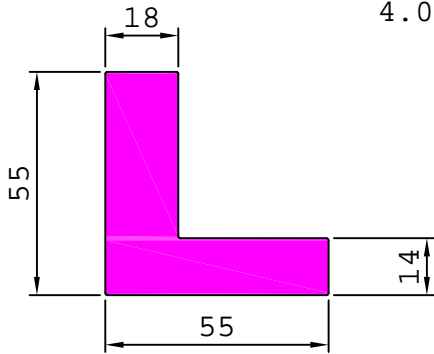

4.071 kg/m

25133

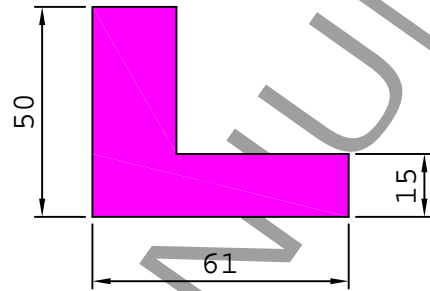

4.361 kg/m

25118

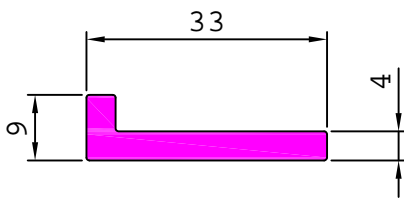

0.410 kg/m

25140

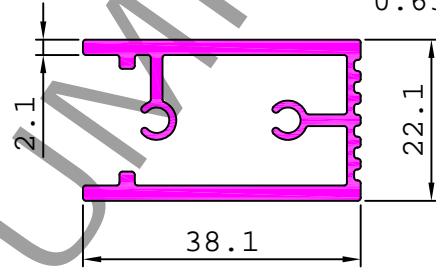

0.633 kg/m

25129

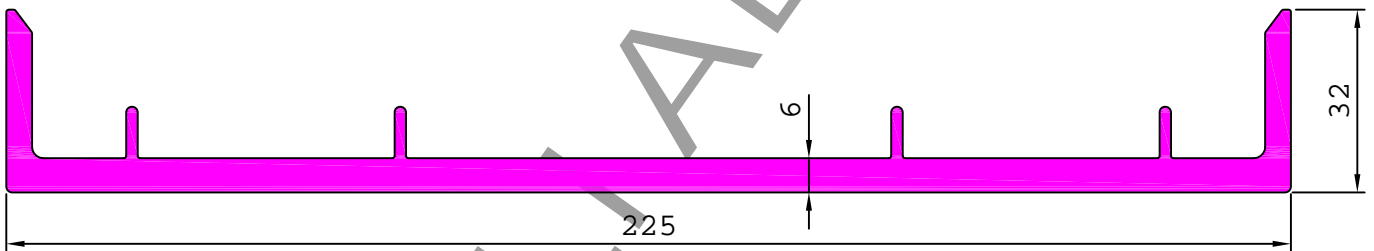

4.438 kg/m

25139

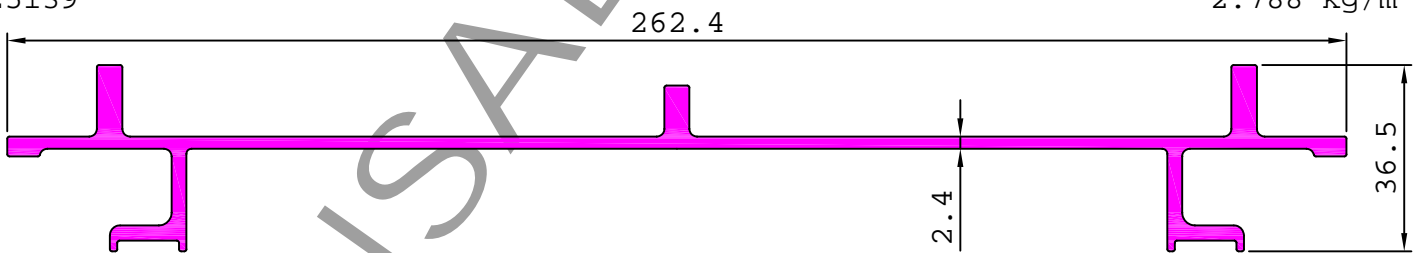

262.4

2.788 kg/m

25142

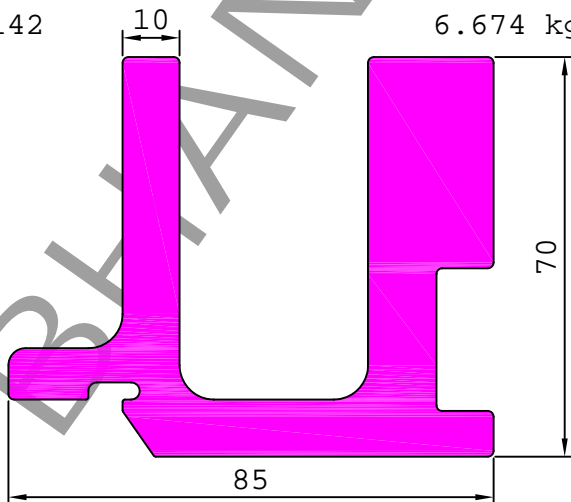

6.674 kg/m

25143

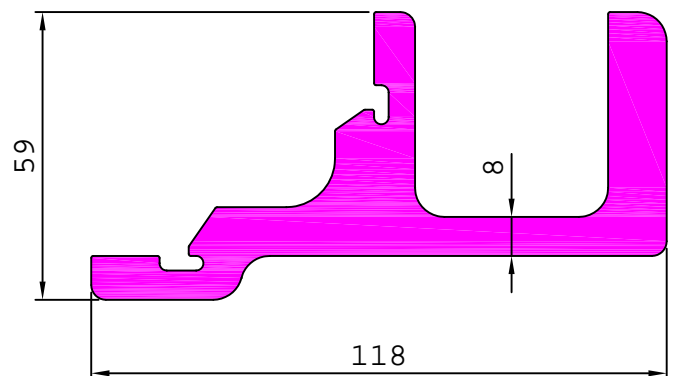

5.654 kg/m

INDUSTRIAL

ELECTRICALS

25144

6.401 kg/m

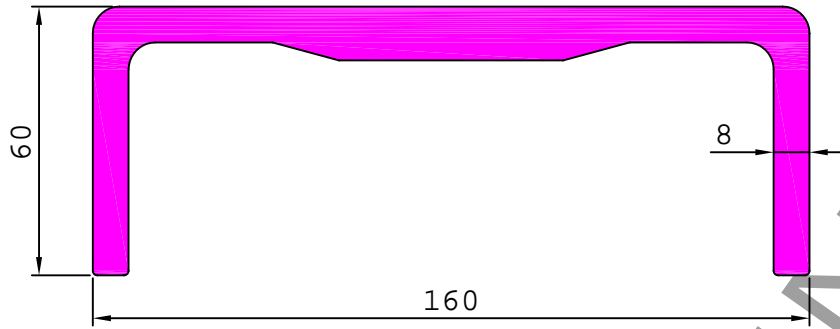

25145

2.704 kg/m

25146

4.184 kg/m

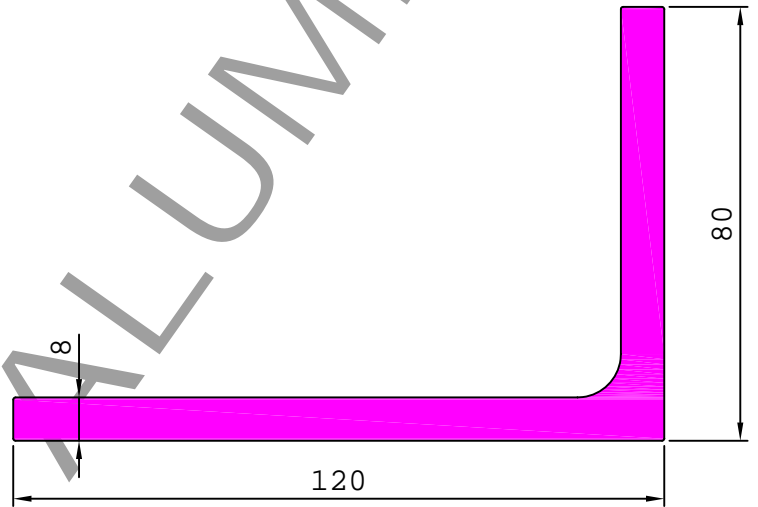
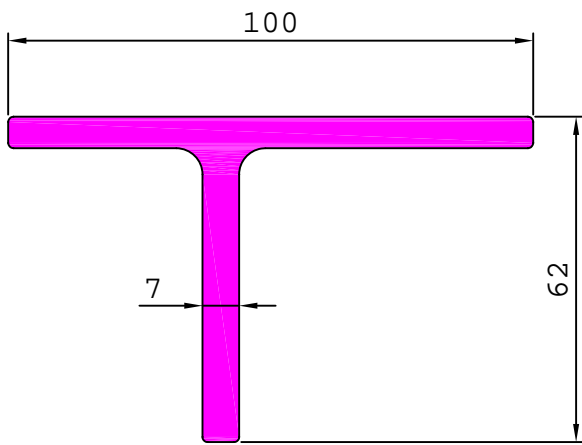

25147

2.930 kg/m

25148

0.307 kg/m

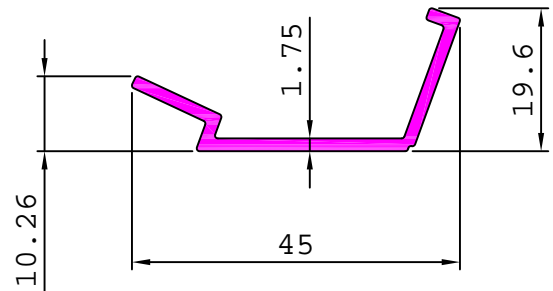
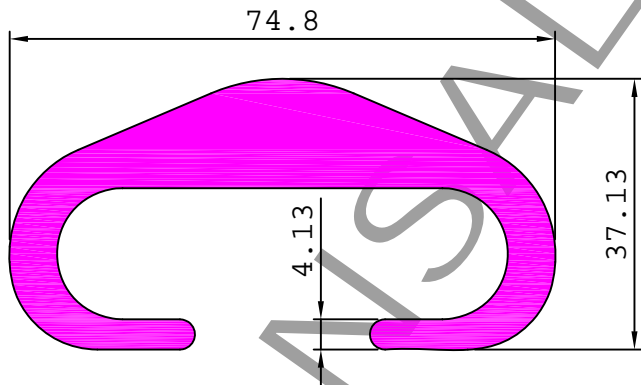

25150

1.026 kg/m

25153

4.158 kg/m

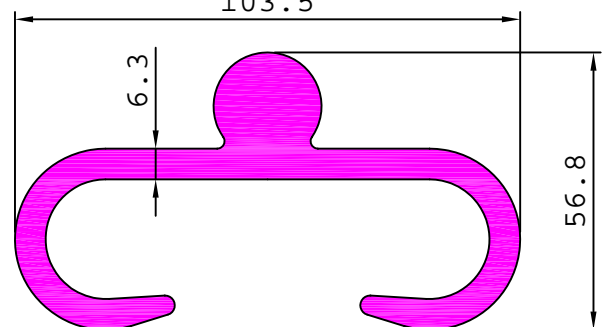
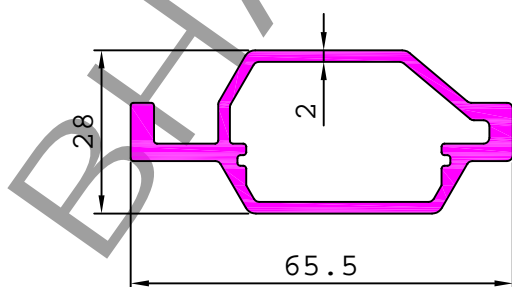

INDUSTRIAL

ELECTRICALS

25154

1.194 kg/m

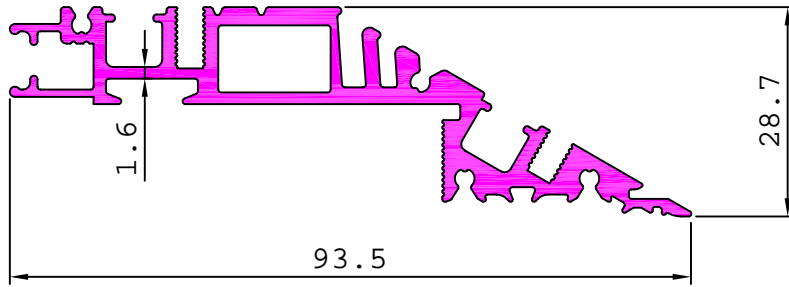

25157

0.523 kg/m

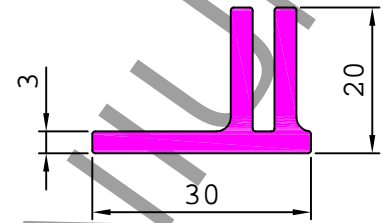

25158

2.407 kg/m

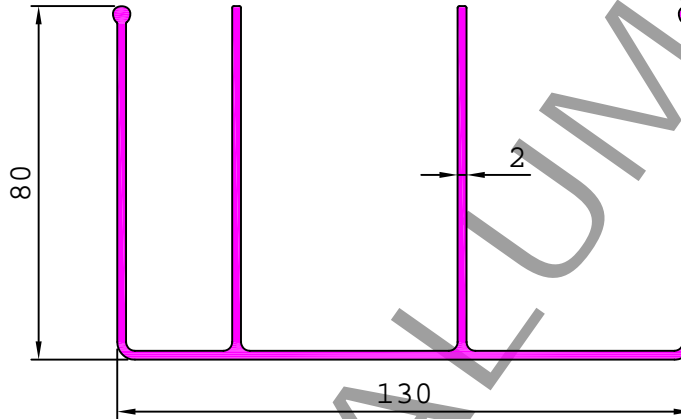

25159

3.685 kg/m

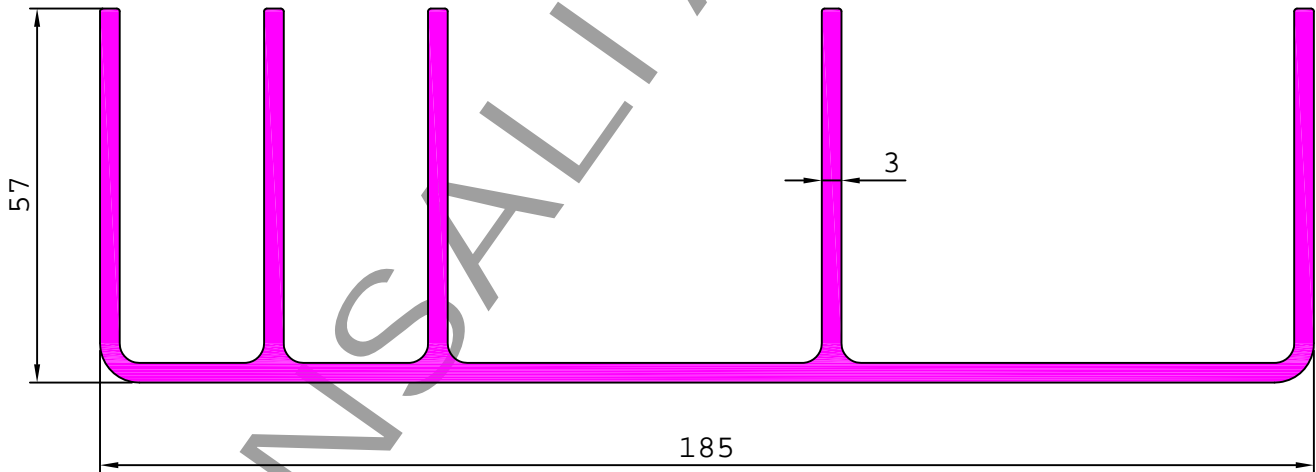

25160

3.156 kg/m

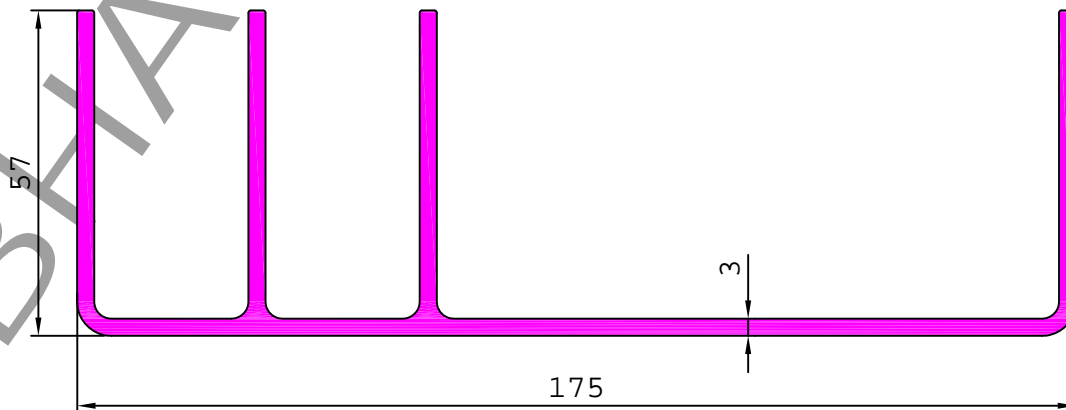

INDUSTRIAL

ELECTRICALS

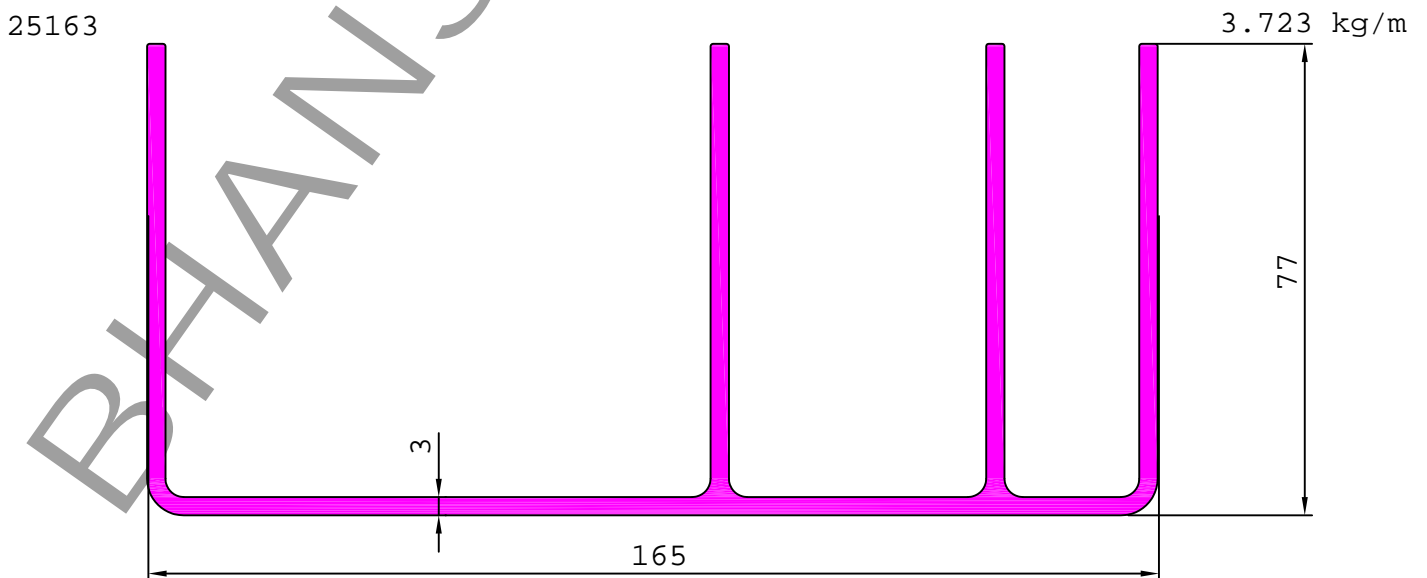
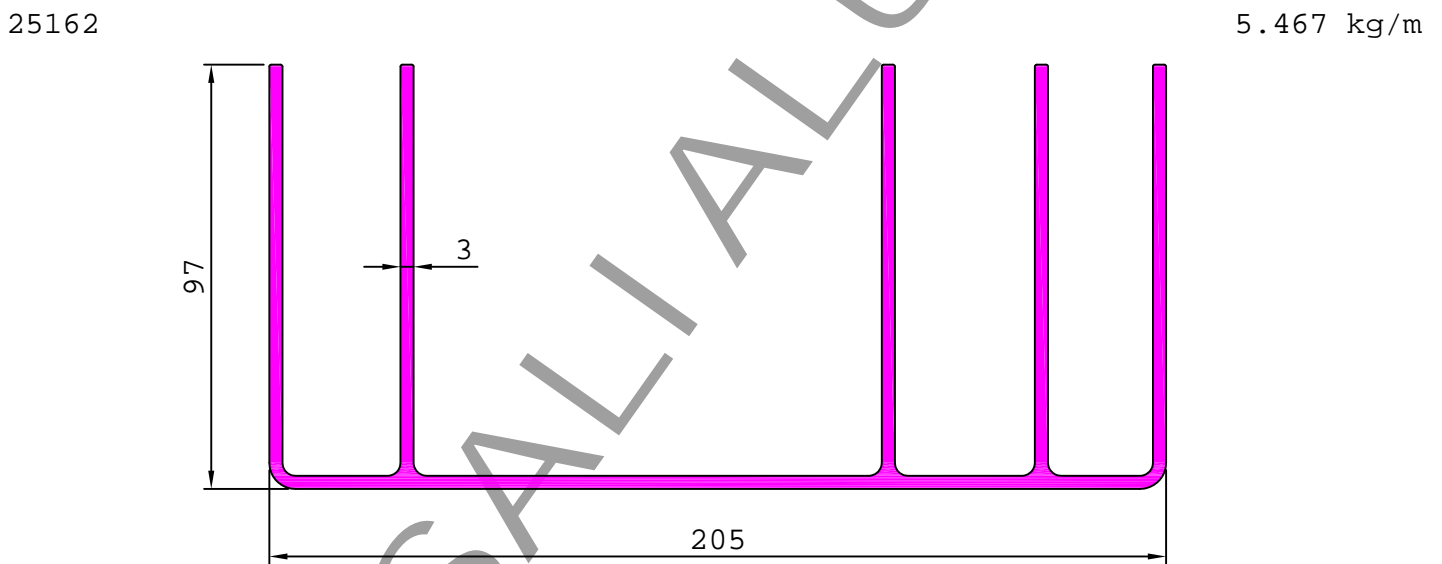
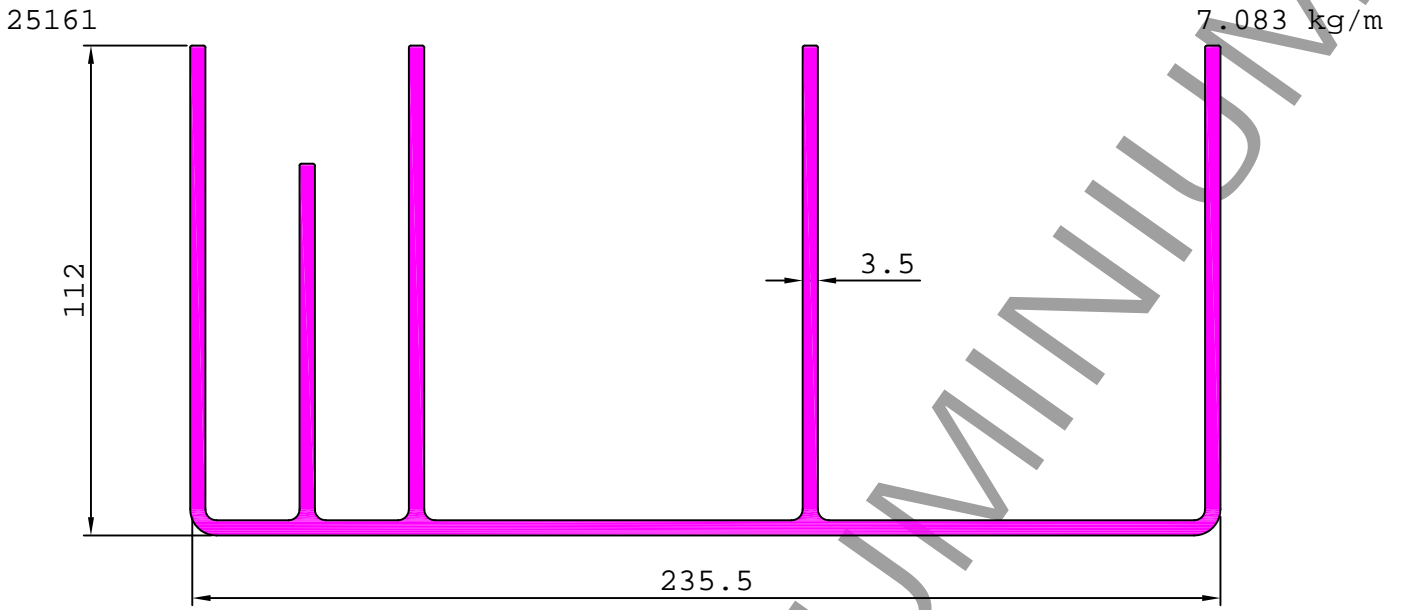

INDUSTRIAL

ELECTRICALS

25164

3.885 kg/m

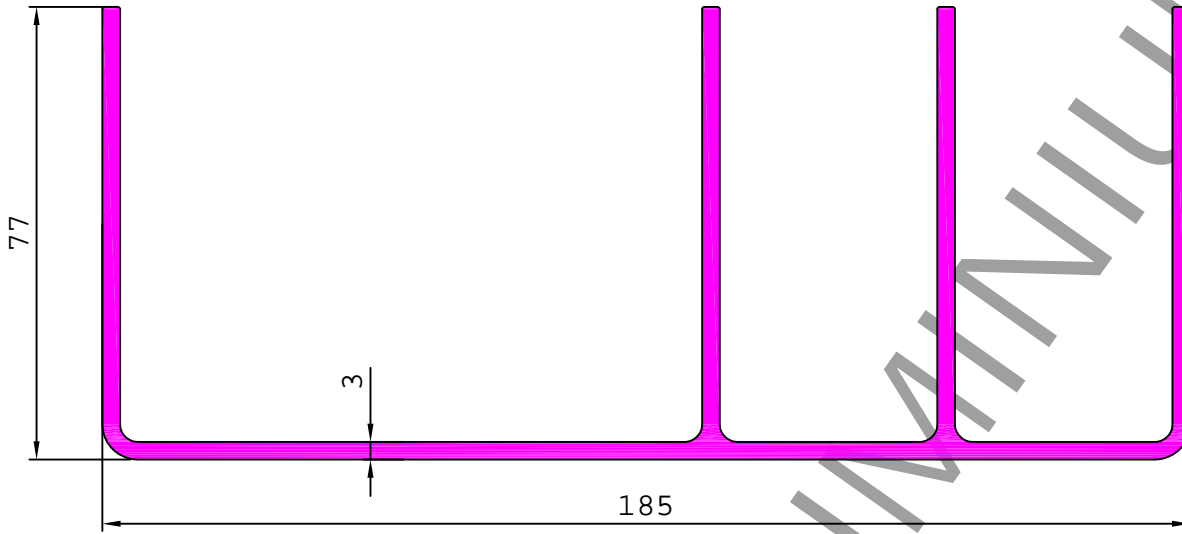

25165

4.893 kg/m

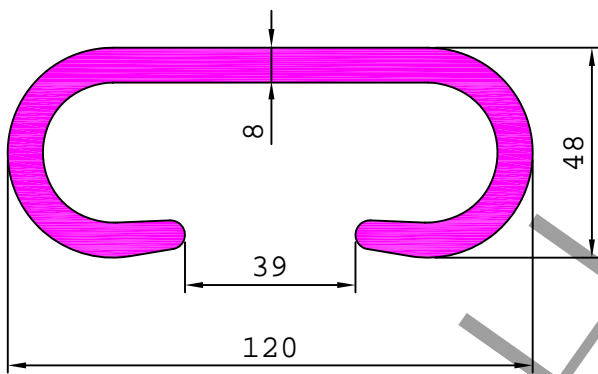

25166

2.048 kg/m

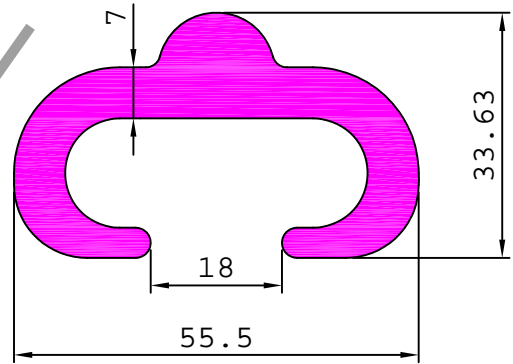

25167

0.940 kg/m

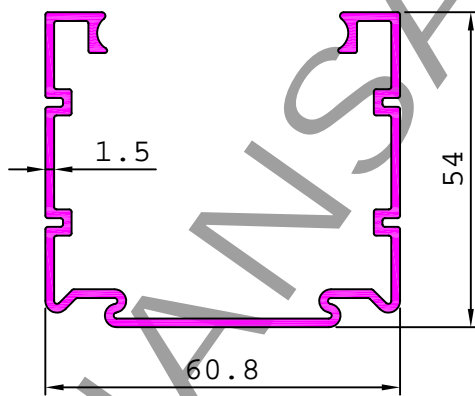

25171

0.717 kg/m

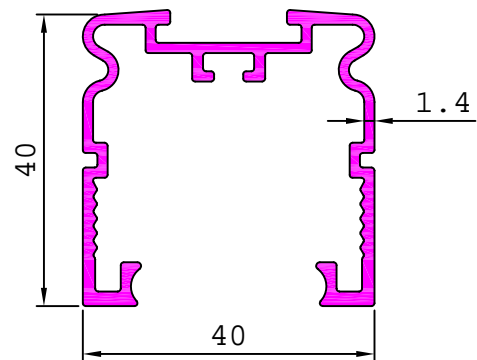

25168

0.250 kg/m

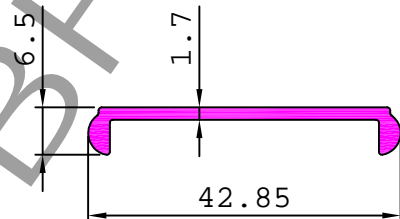

25170

1.795 kg/m

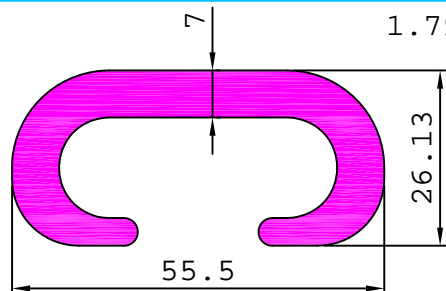

INDUSTRIAL

ELECTRICALS

25172

1.250 kg/m

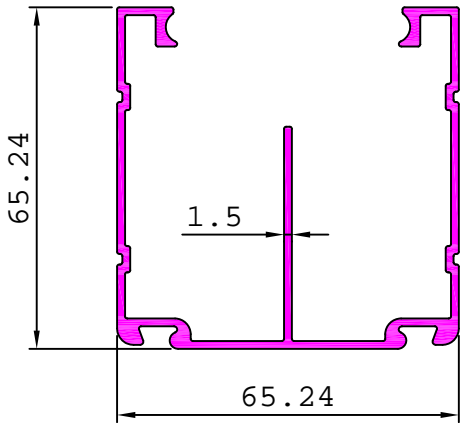

25173

0.150 kg/m

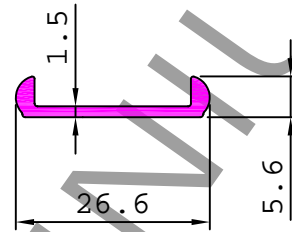

25174

1.999 kg/m

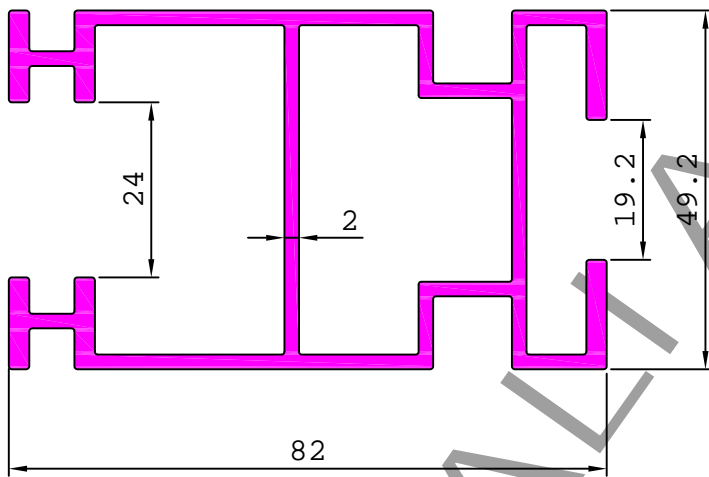

25175

6.210 kg/m

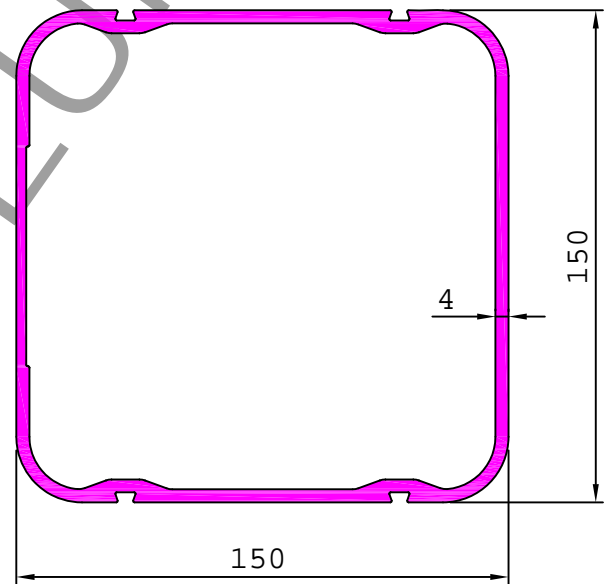

25176

1.397 kg/m

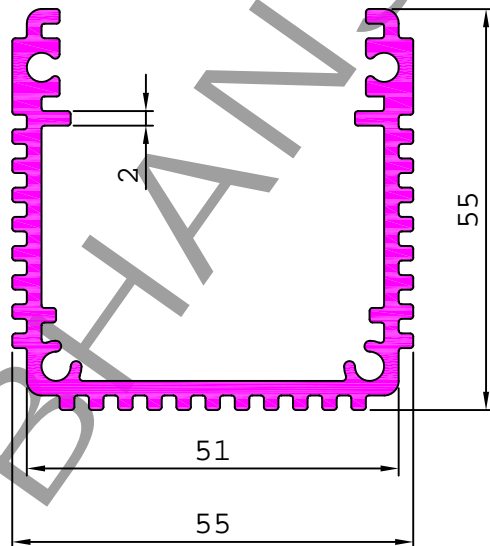

25177

2.469 kg/m

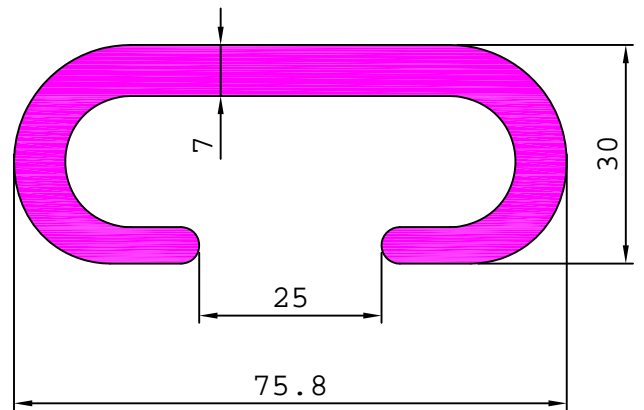

INDUSTRIAL

ELECTRICALS

25178

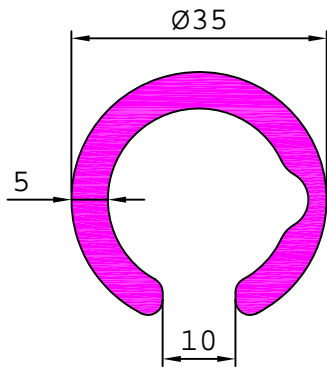

1.080 kg/m

25179

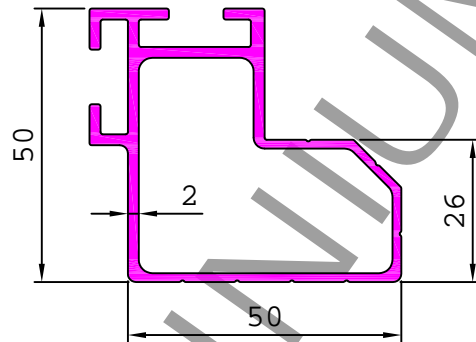

1.124 kg/m

25180

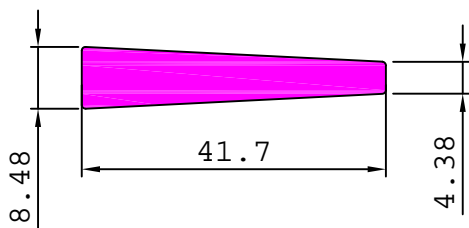

0.726 kg/m

25181

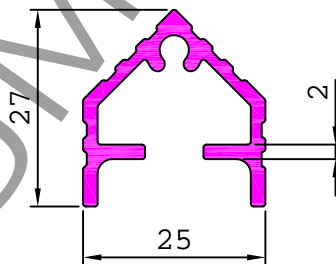

0.409 kg/m

25182

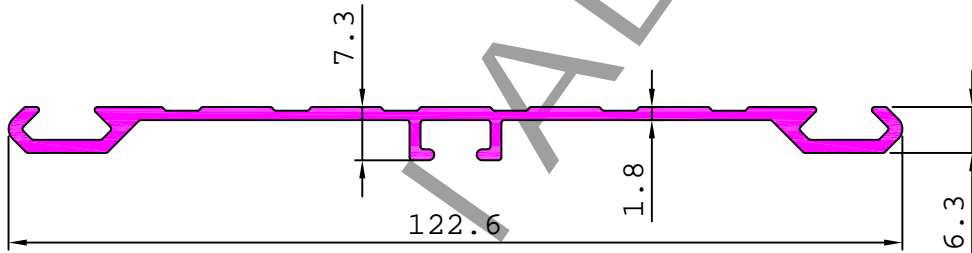

0.721 kg/m

25183

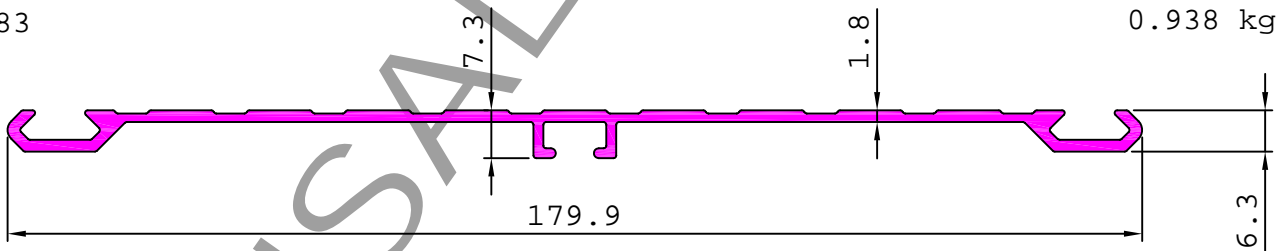

0.938 kg/m

25184

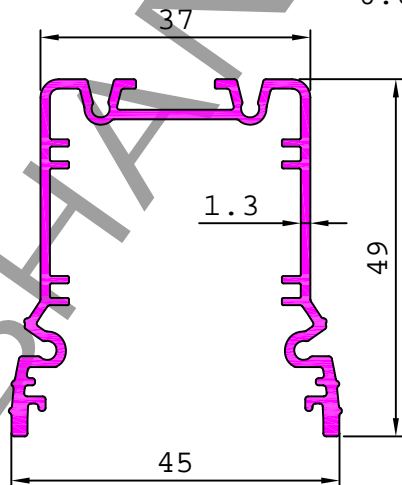

0.695 kg/m

25185

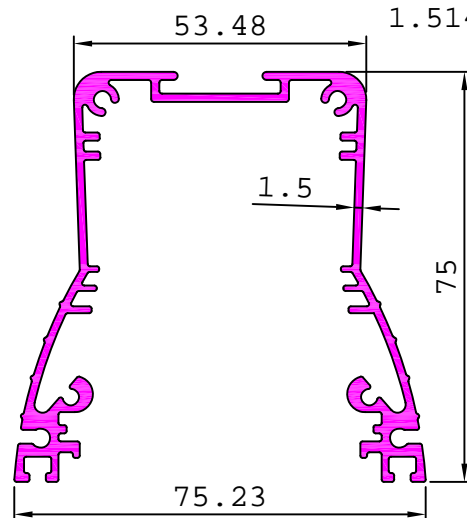

1.514 kg/m

INDUSTRIAL

ELECTRICALS

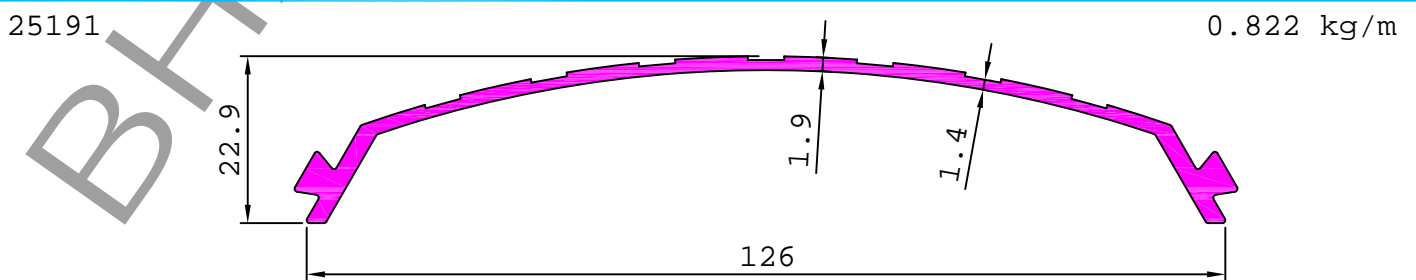
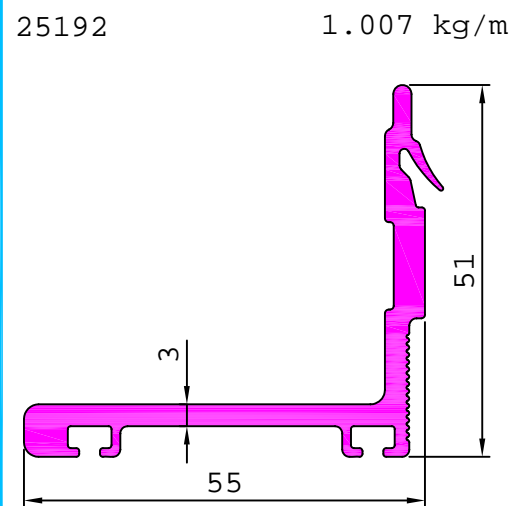
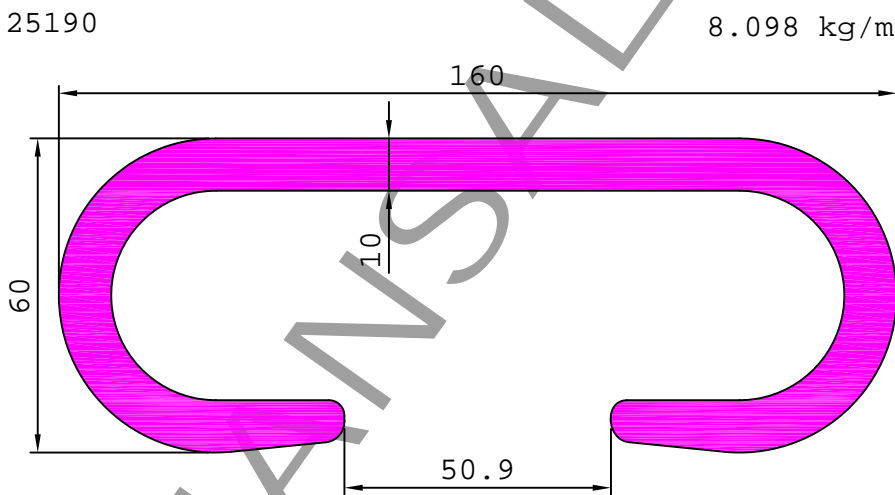
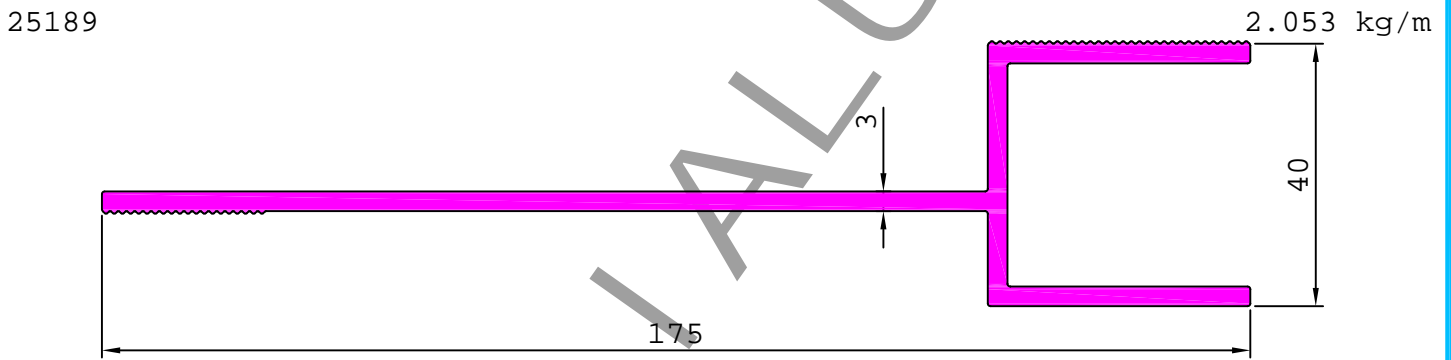
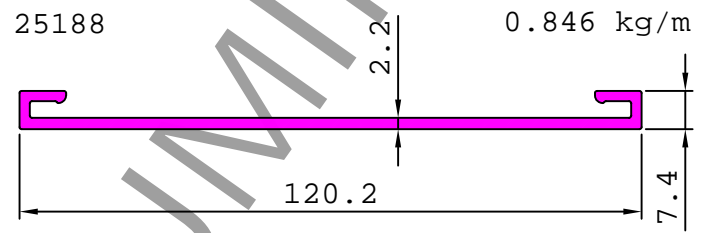
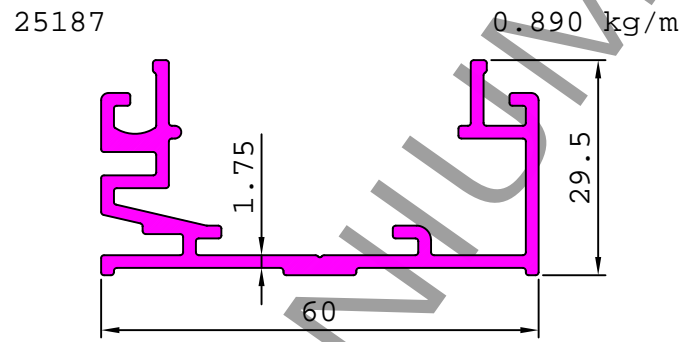
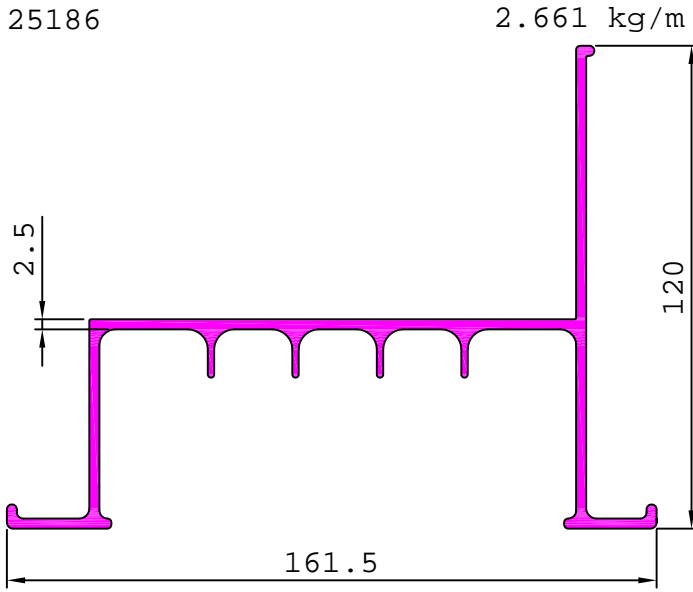

INDUSTRIAL

ELECTRICALS

25193

7.616 kg/m

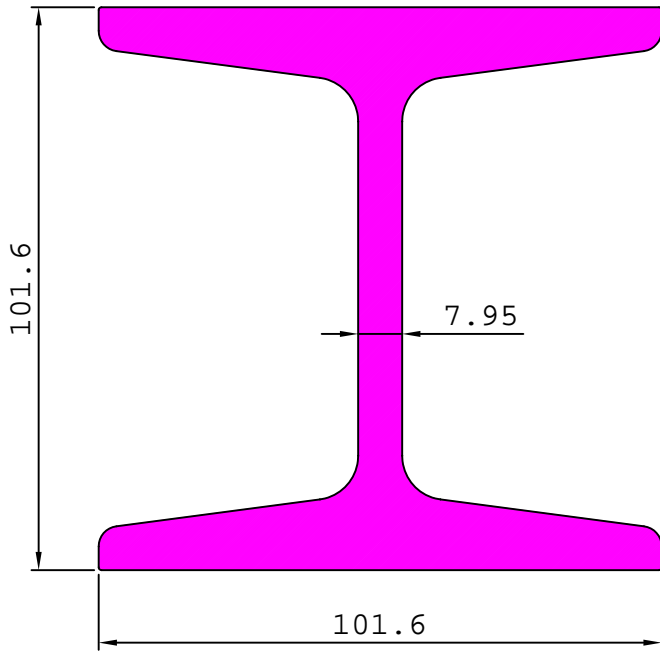

25194

8.013 kg/m

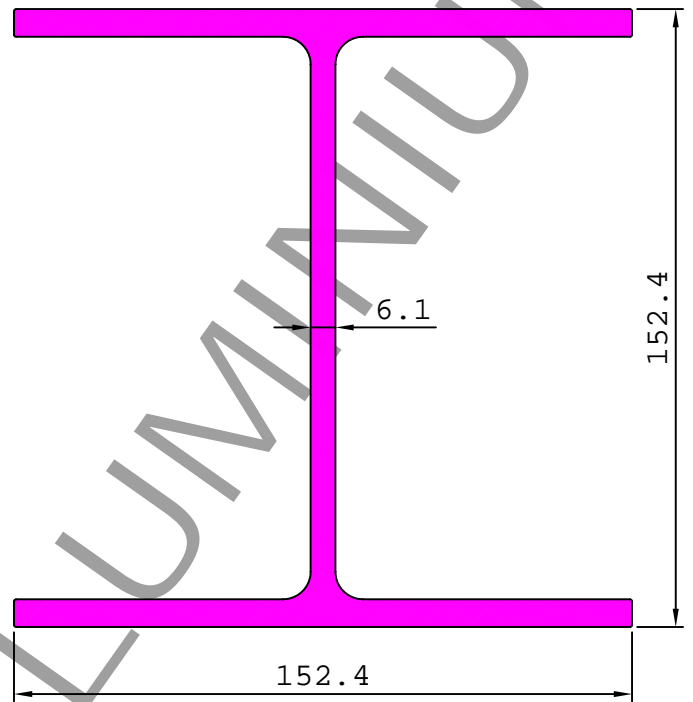

25195

14.007 kg/m

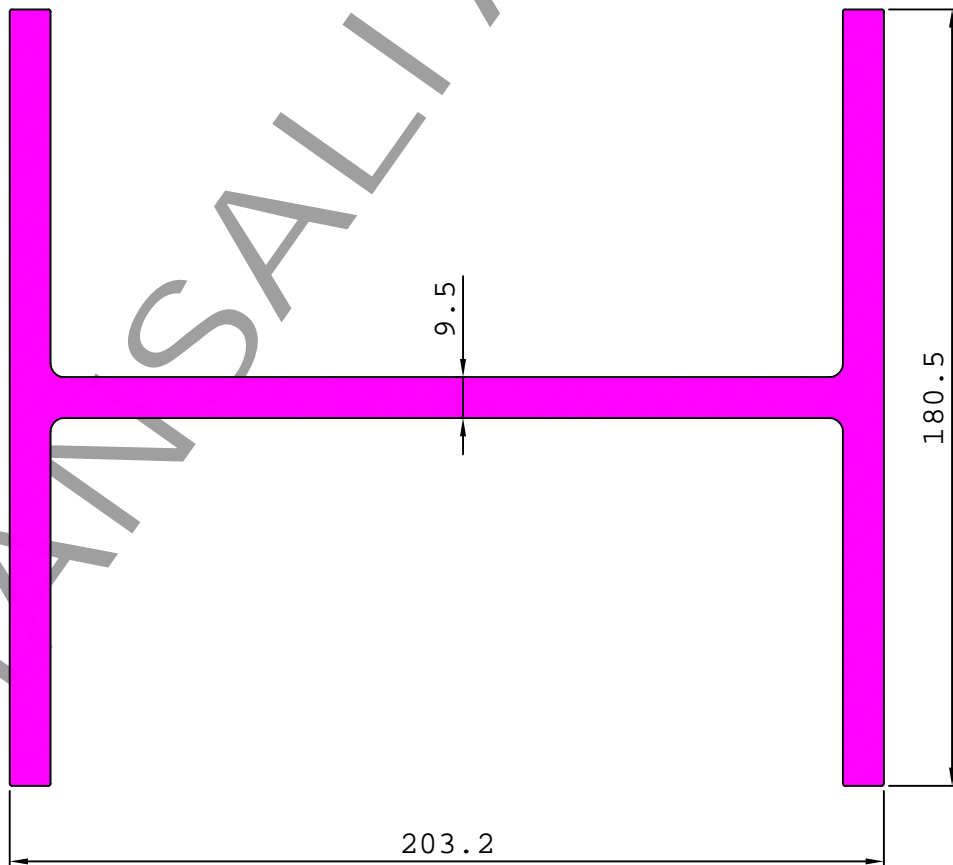

INDUSTRIAL

ELECTRICALS

25196

0.725 kg/m

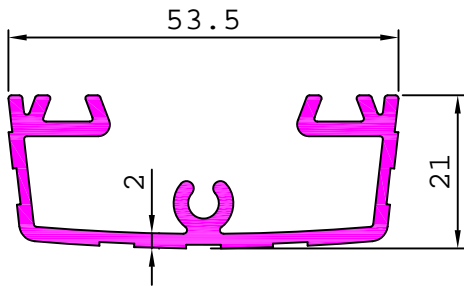

25197

0.257 kg/m

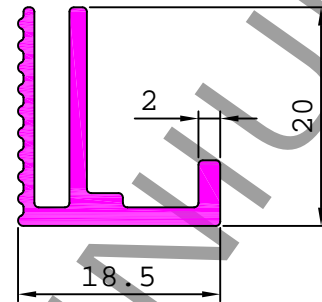

25198

0.865 kg/m

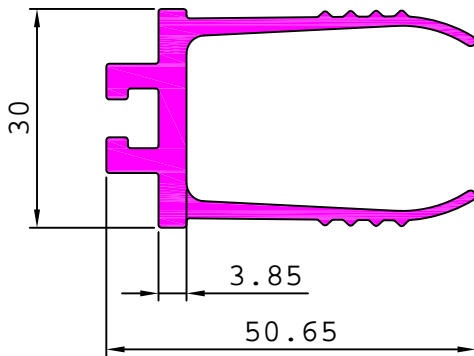

25199

0.435 kg/m

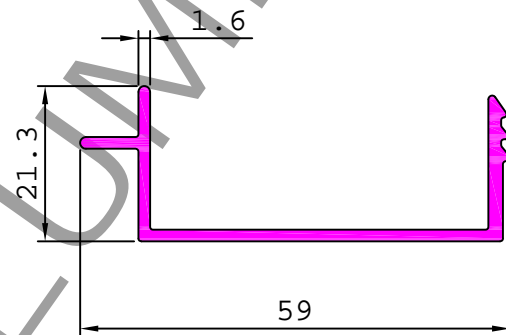

25200

2.911 kg/m

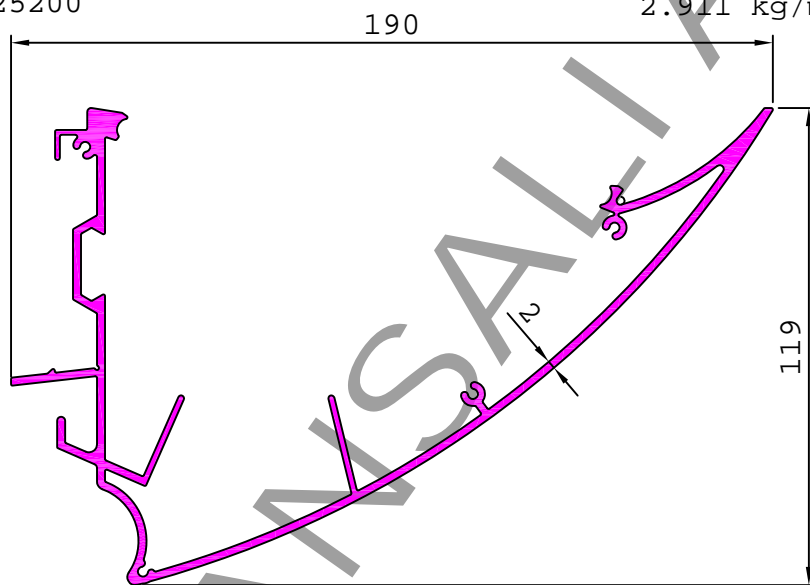

25201

0.173 kg/m

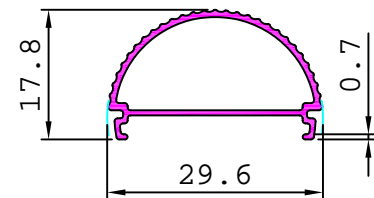

25202

0.212 kg/m

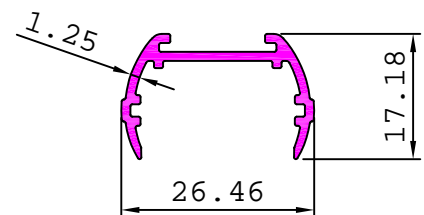

25203

0.418 kg/m

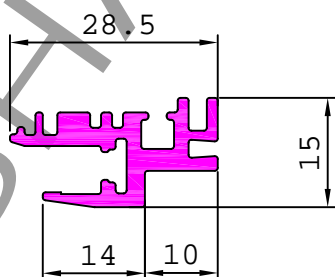

25204

0.117 kg/m

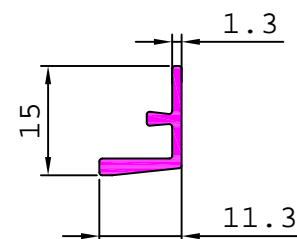

INDUSTRIAL

ELECTRICALS

25205

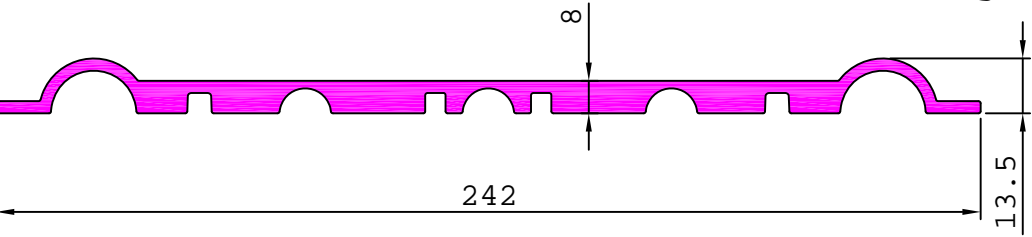

3.640 kg/m

25207

0.185 kg/m

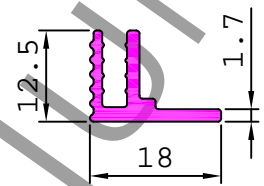

25206

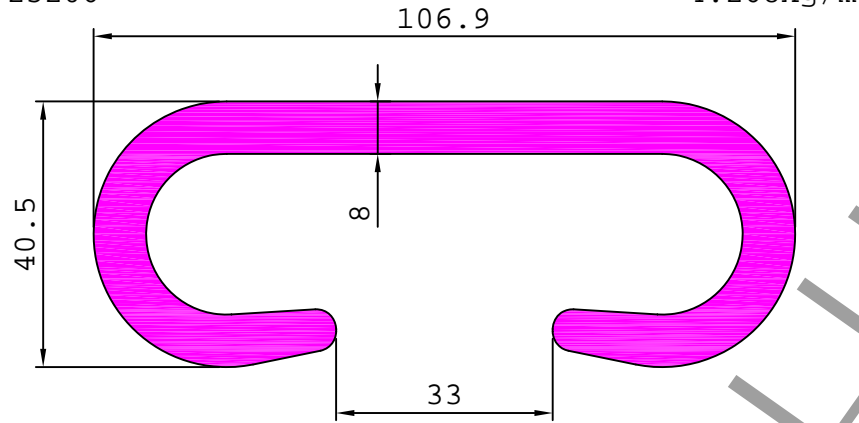

4.268kg/m

25208

0.201 kg/m

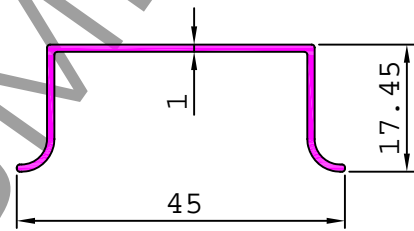

25209

0.232 kg/m

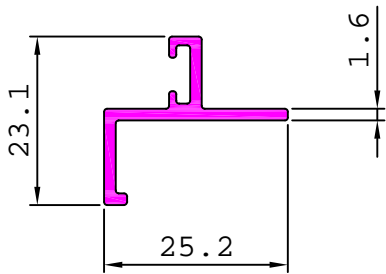

25210

0.103 kg/m

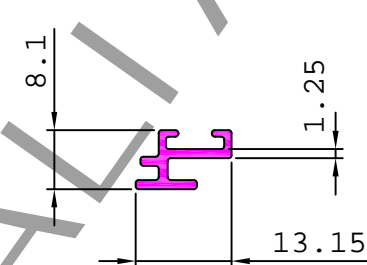

25211

0.087 kg/m

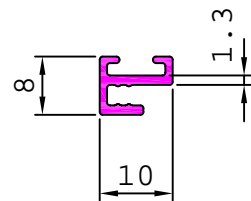

25212

0.447 kg/m

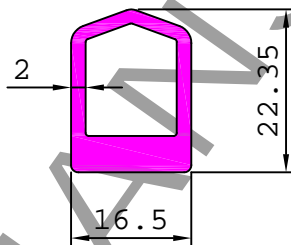

25213

0.824 kg/m

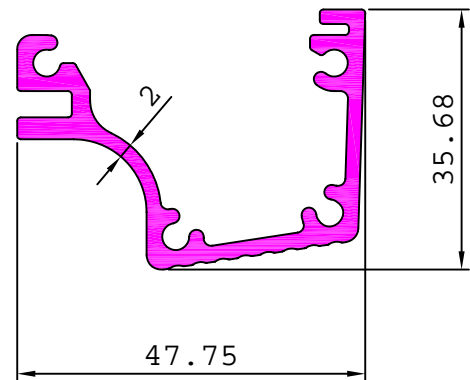

25214

0.129 kg/m

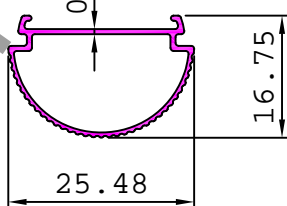

INDUSTRIAL

ELECTRICALS

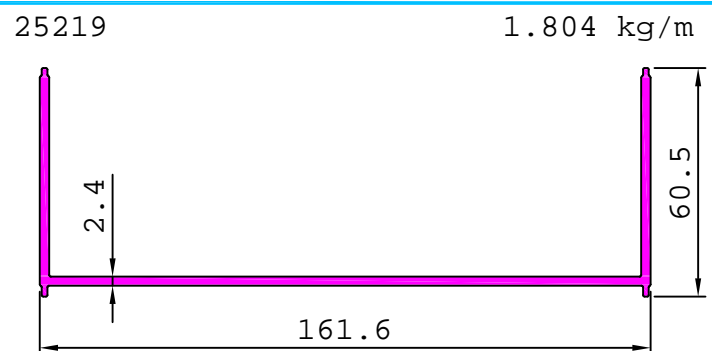
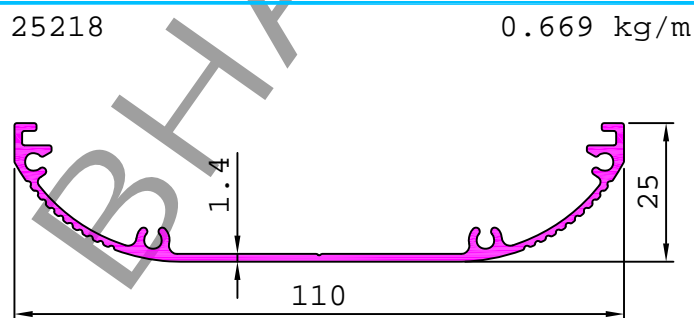
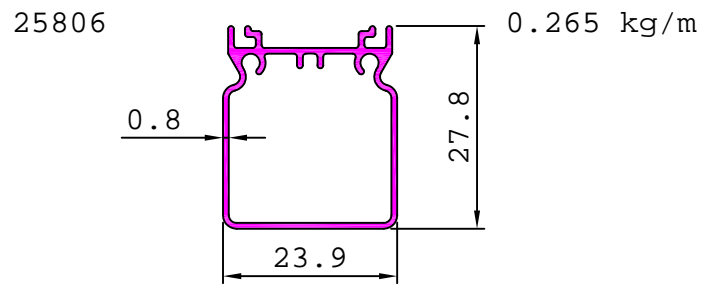
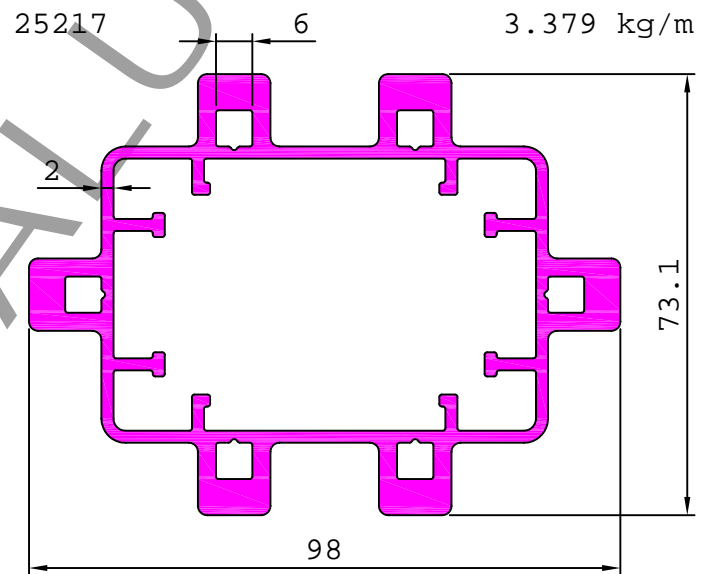
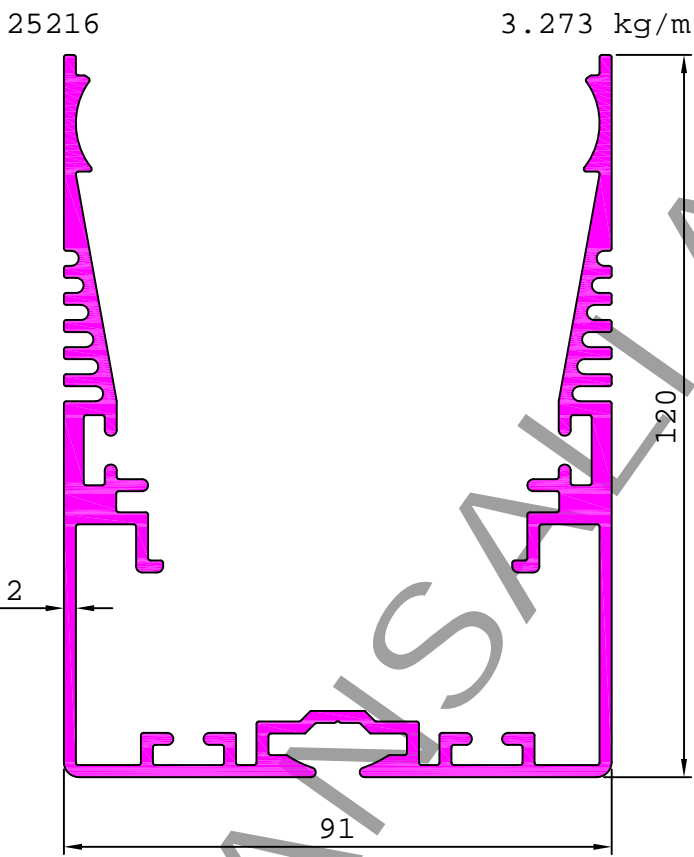
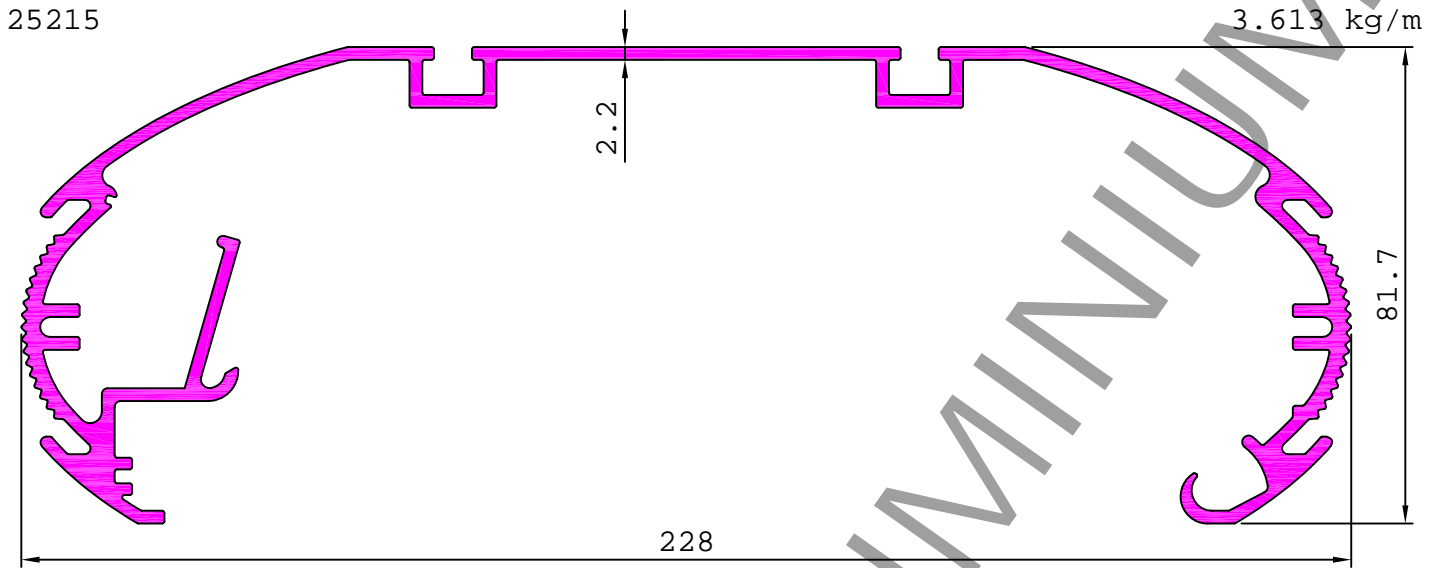

INDUSTRIAL

ELECTRICALS

25220

1.771 kg/m

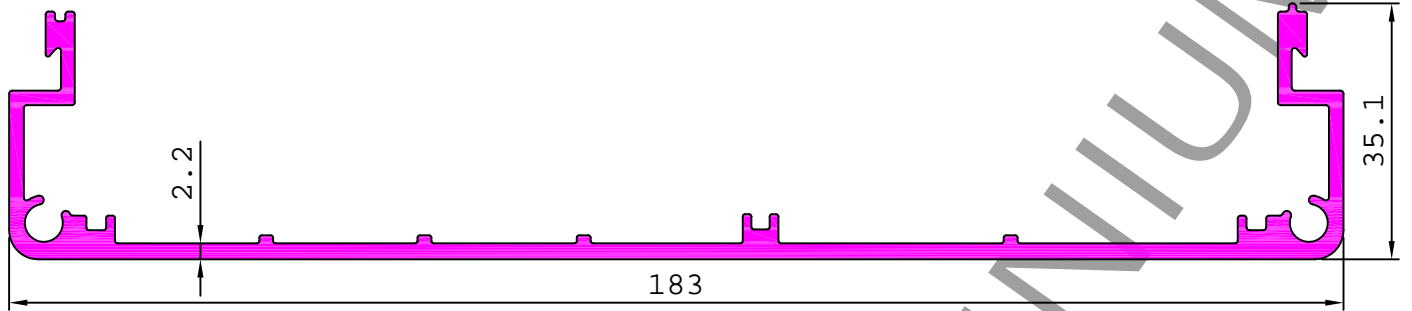

S3521

2.827 kg/m

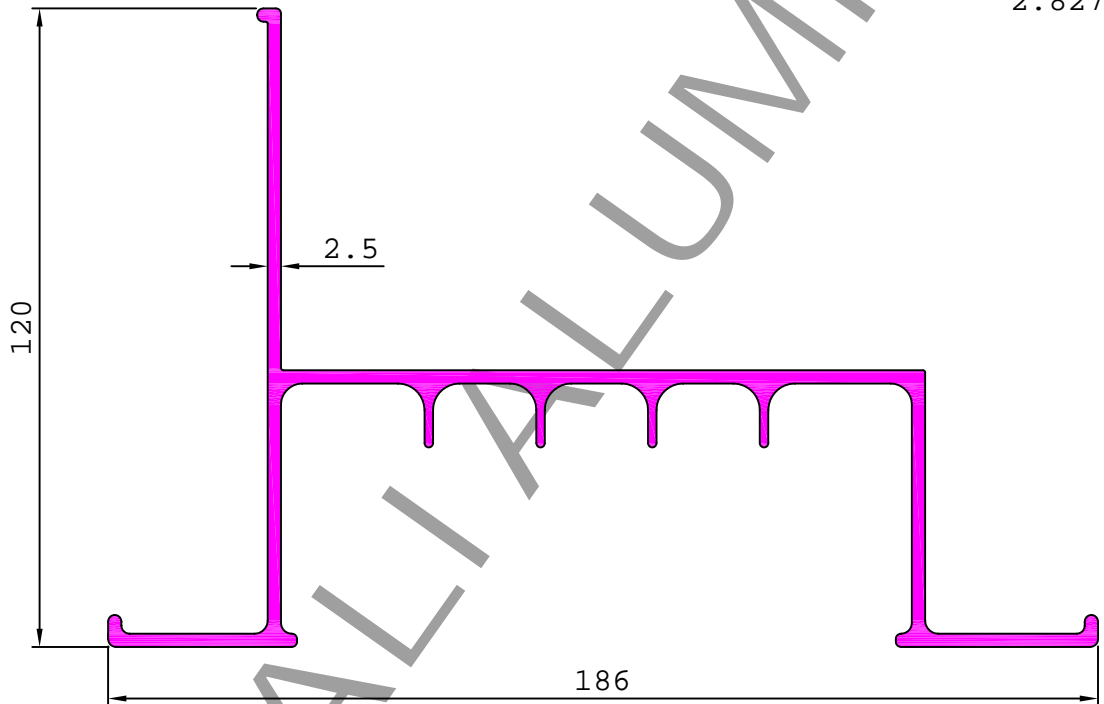

S3471

2.733 kg/m

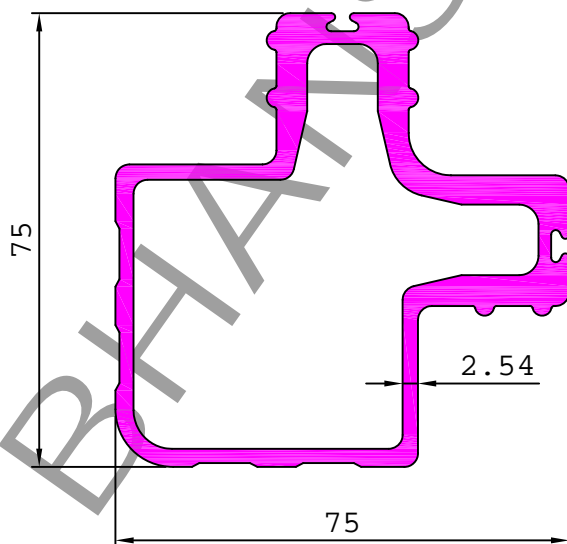

S3562

6.850 kg/m

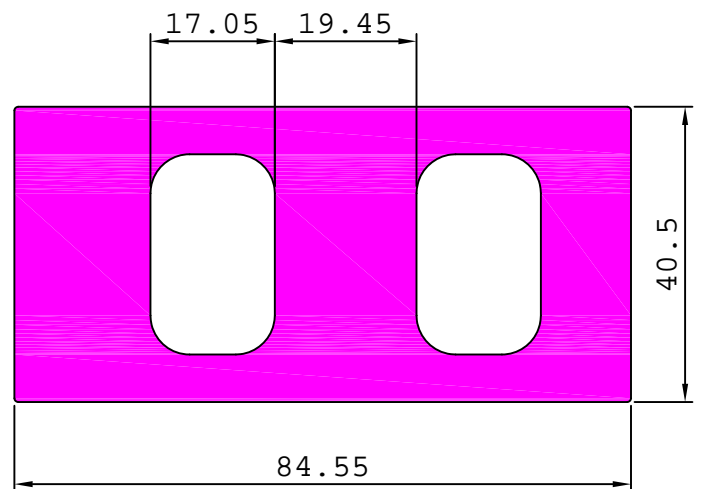

INDUSTRIAL

ELECTRICALS

S3642

20.074 kg/m

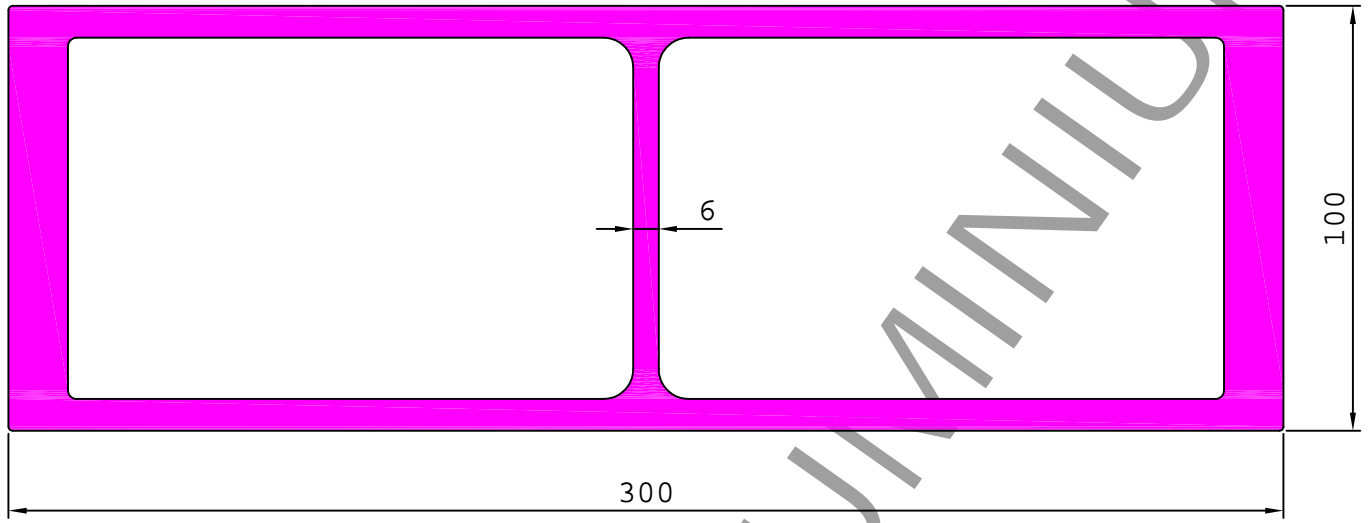

S3645

10.729 kg/m

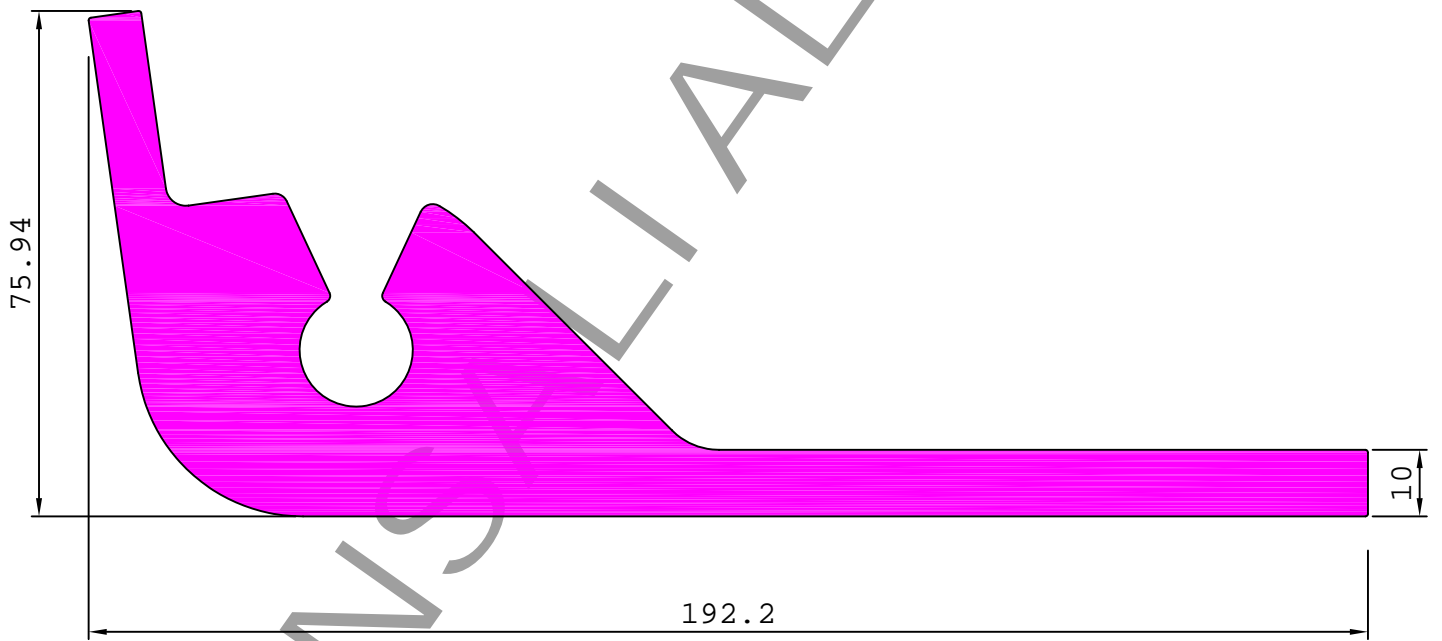

S3660

0.630 kg/m

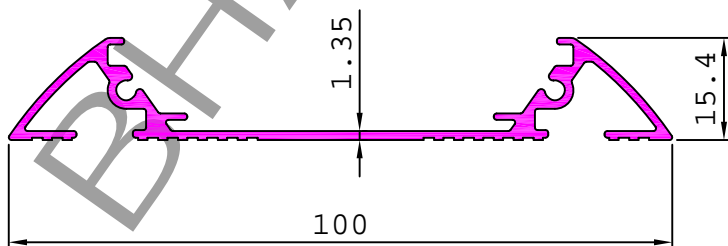

S3706

1.350 kg/m

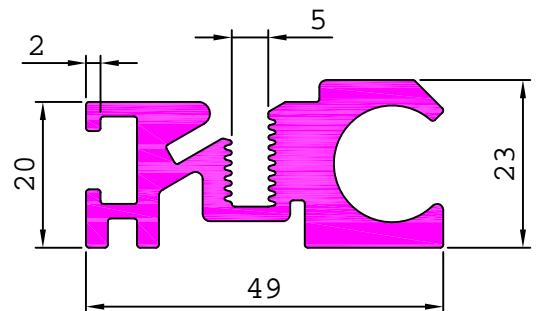

INDUSTRIAL

ELECTRICALS

S3646

10.742 kg/m

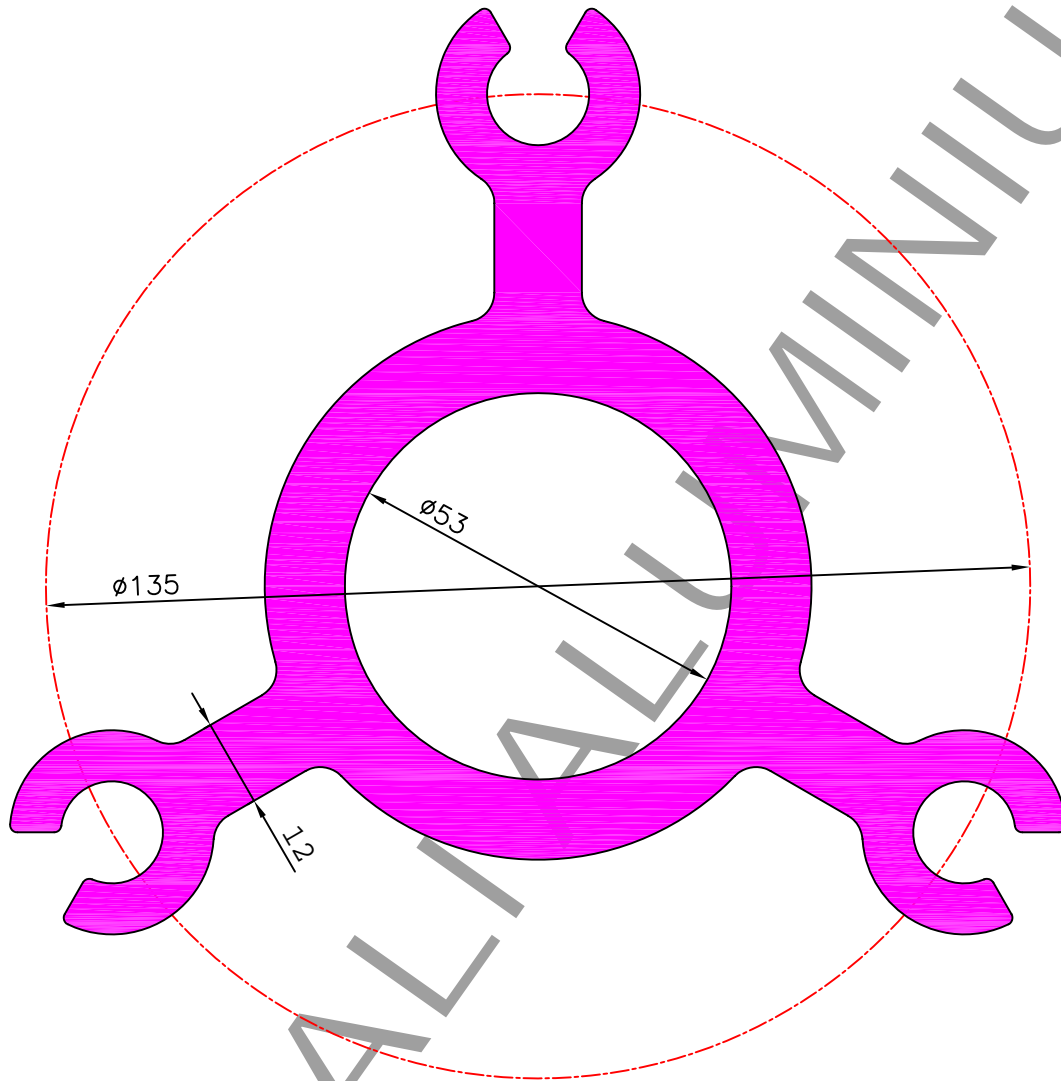

S3662

1.539 kg/m

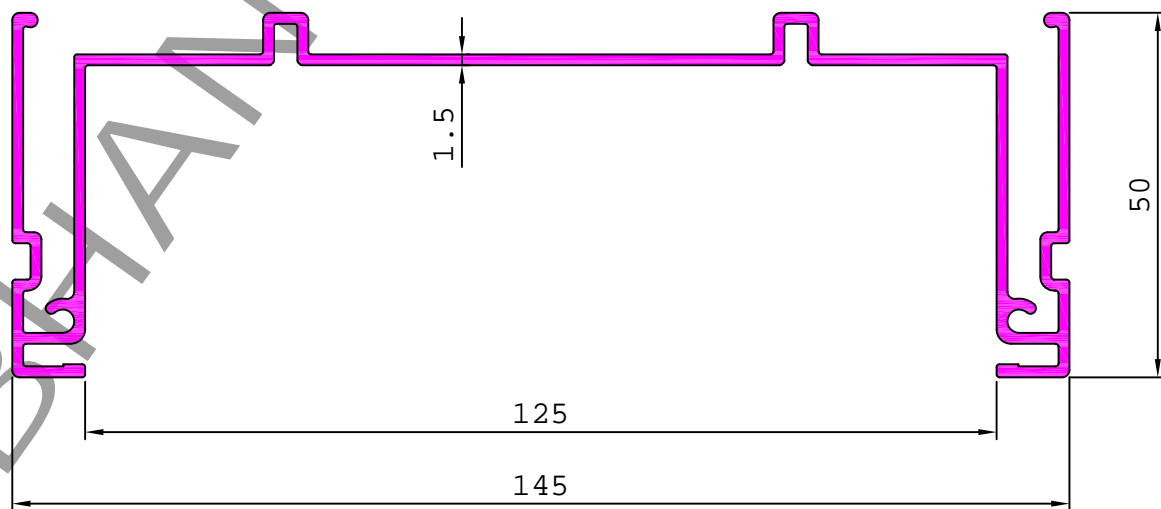

INDUSTRIAL

ELECTRICALS

S3663

1.341 kg/m

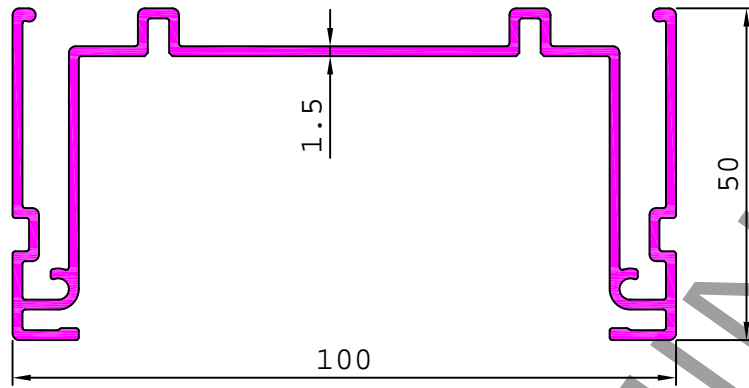

S3710

7.787 kg/m

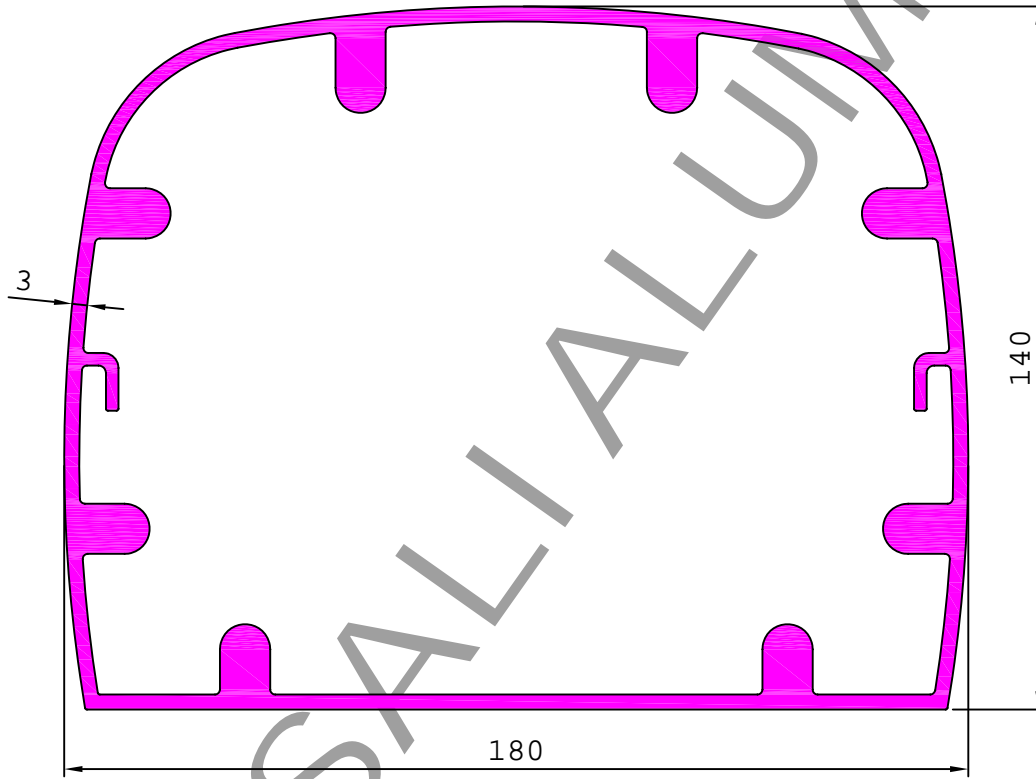

S3711

2.551 kg/m

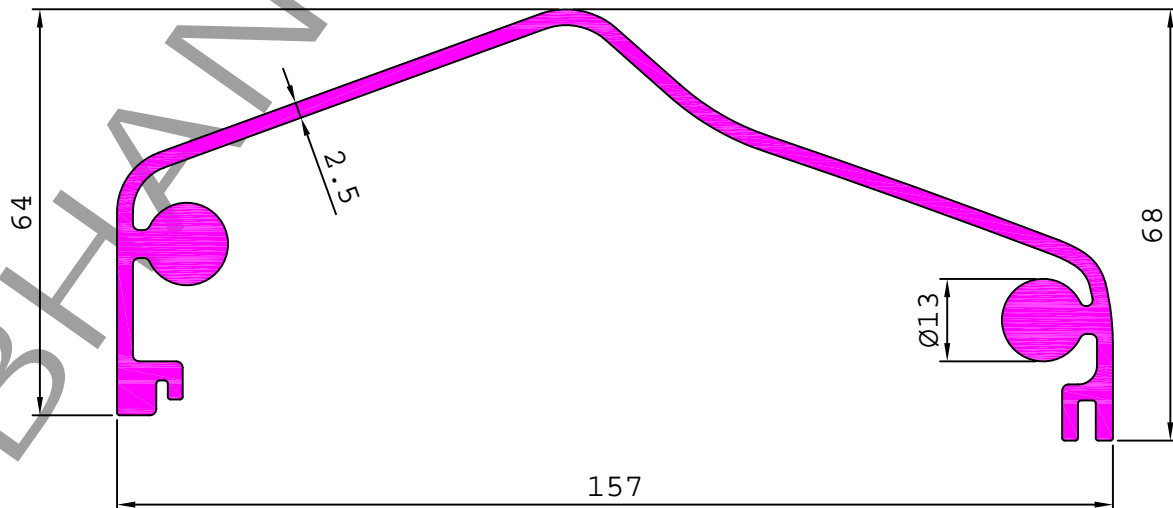

INDUSTRIAL

ELECTRICALS

S3718

19.981 kg/m

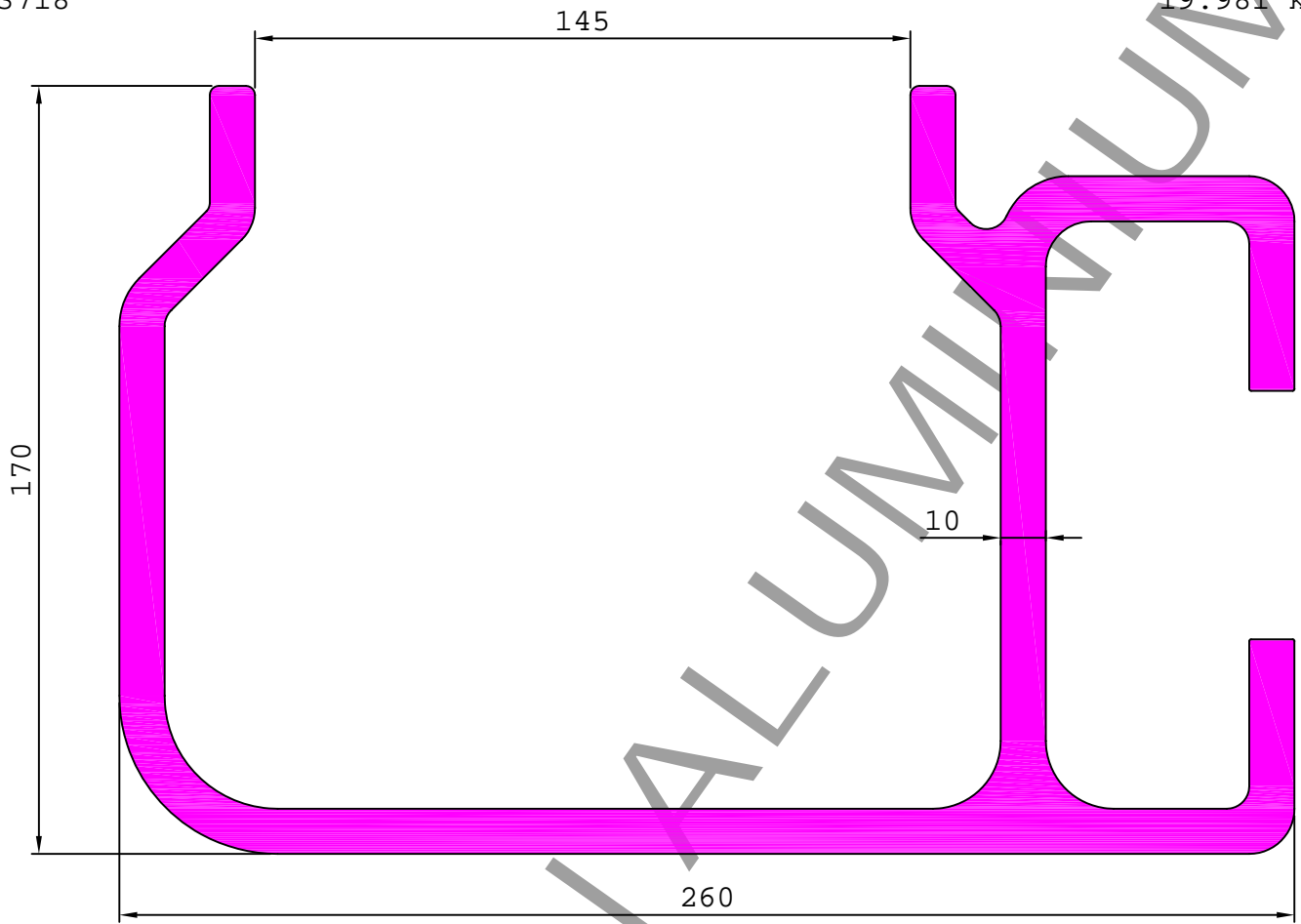

S3720

6.281 kg/m

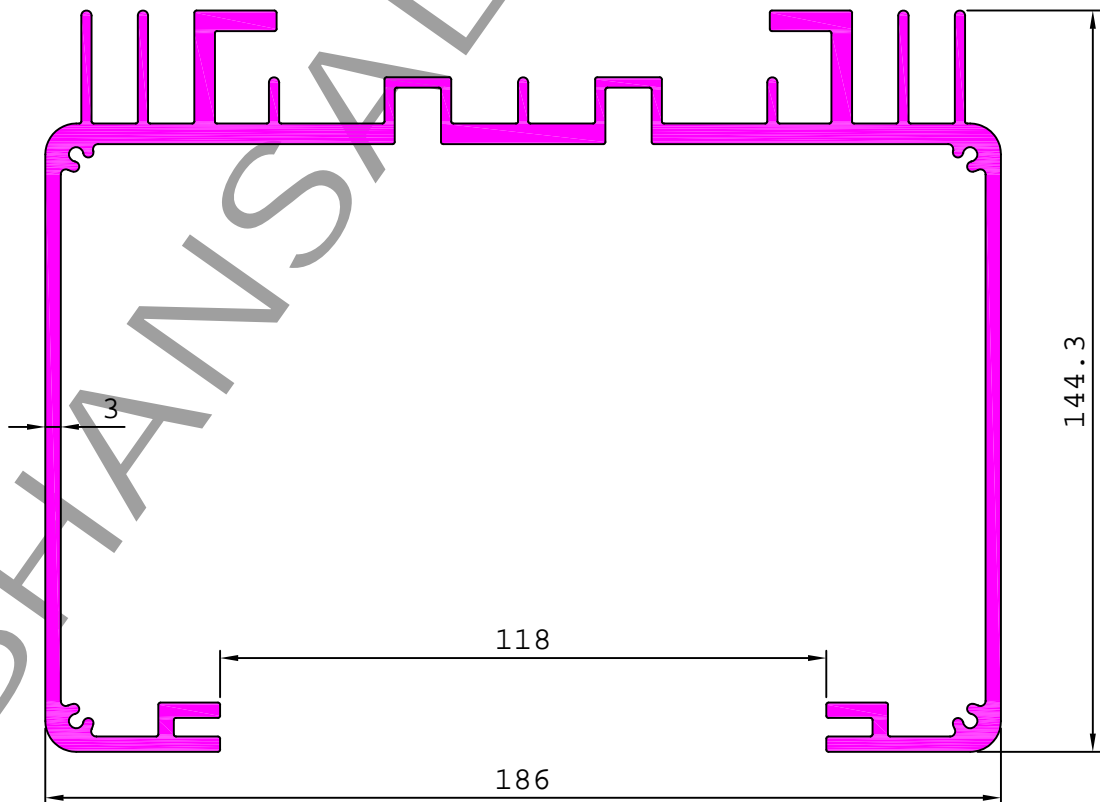

INDUSTRIAL

ELECTRICALS

S3773

2.879 kg/m

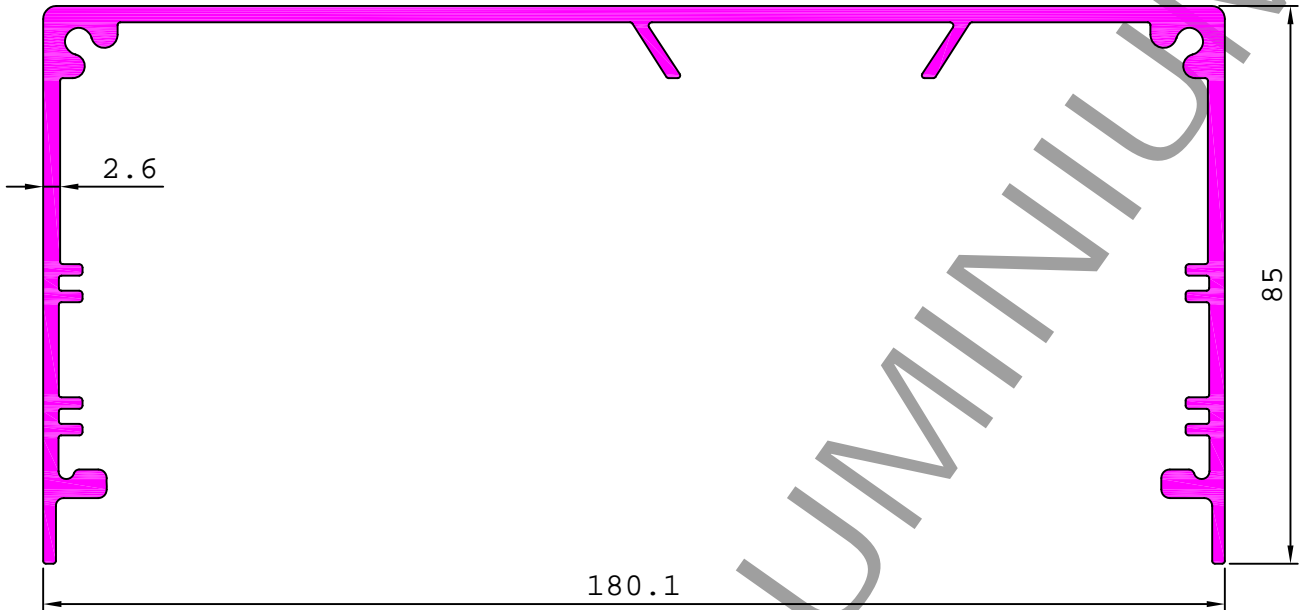

S3782

2.244 kg/m

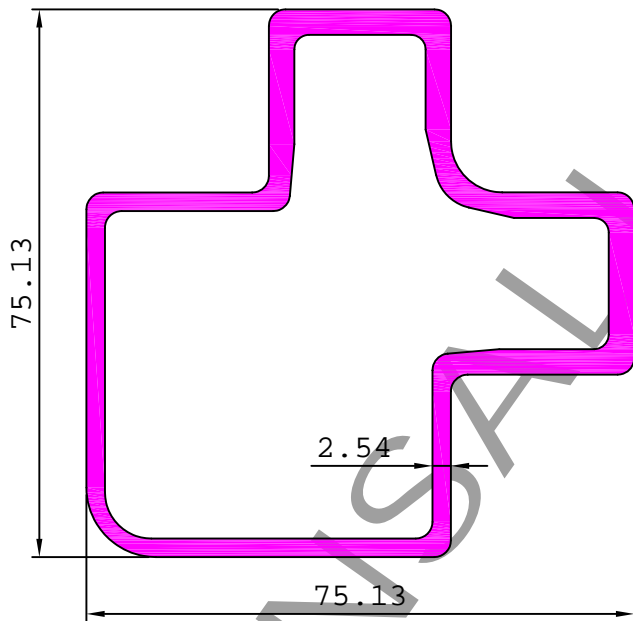

S3808

0.437 kg/m

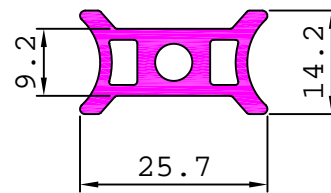

S3853

0.174 kg/m

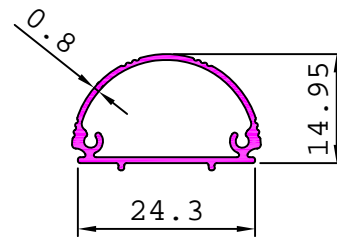

S3873

0.188 kg/m

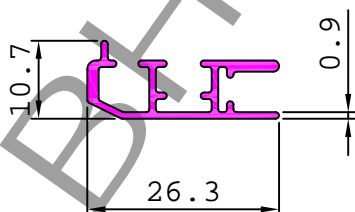

S3886

0.206 kg/m

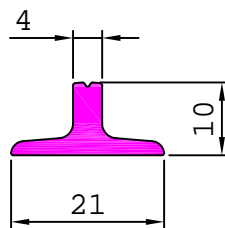

S3887

0.307 kg/m

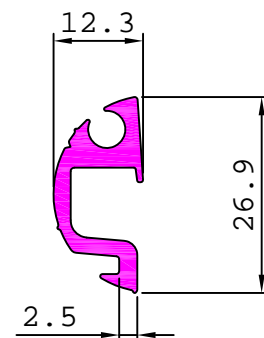

INDUSTRIAL

ELECTRICALS

S3896 0.248 kg/m

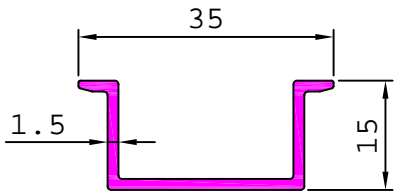

S3925 0.400 kg/m

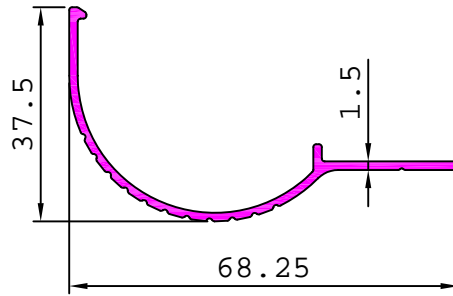

S3927 2.427 kg/m

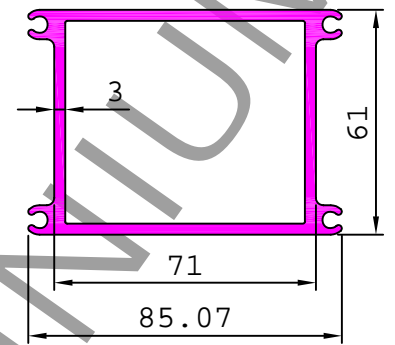

S3926

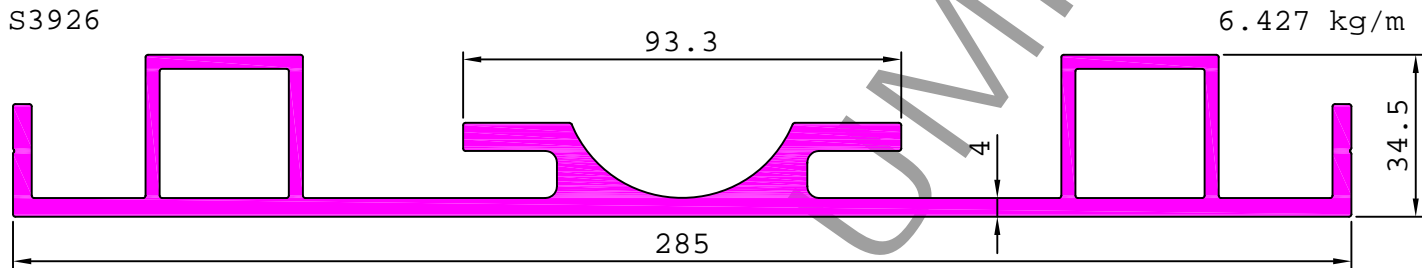

S3933

1.498 kg/m

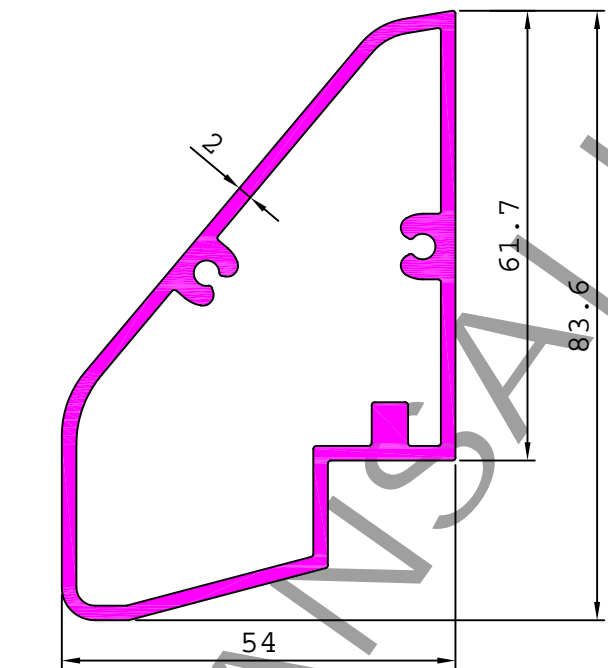

S3987

0.092 kg/m

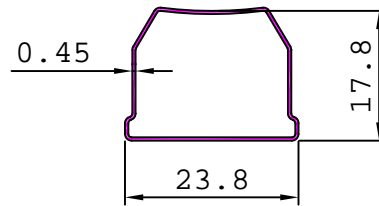

S3988

0.104 kg/m

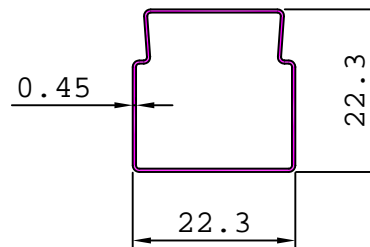

S3951

1.424 kg/m

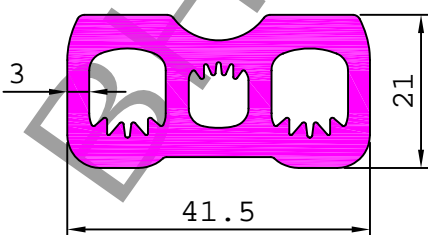

S4028

0.104 kg/m

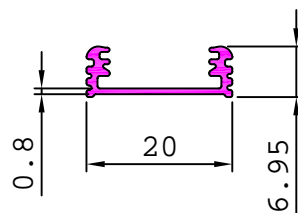

S4029

0.302 kg/m

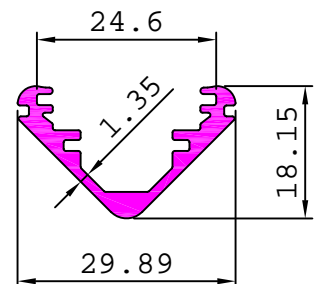

INDUSTRIAL

ELECTRICALS

S4030

2.136 kg/m

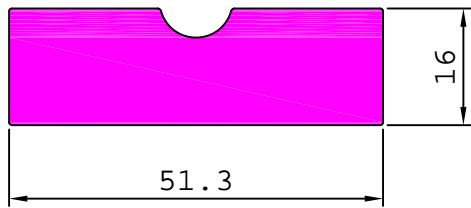

S4062

0.293 kg/m

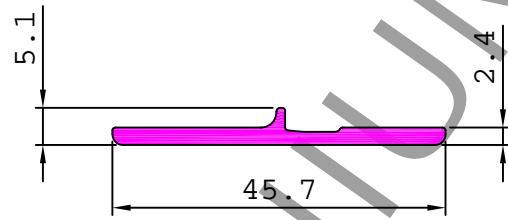

S4055

1.193 kg/m

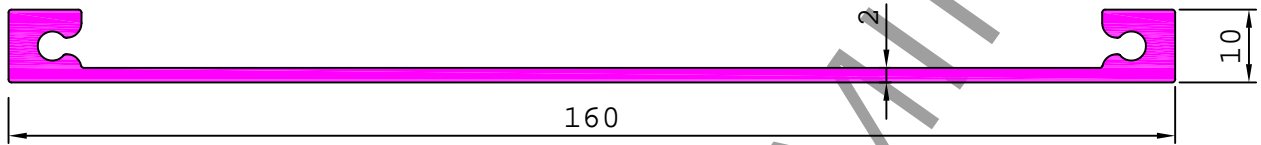

S4066

5.551 kg/m

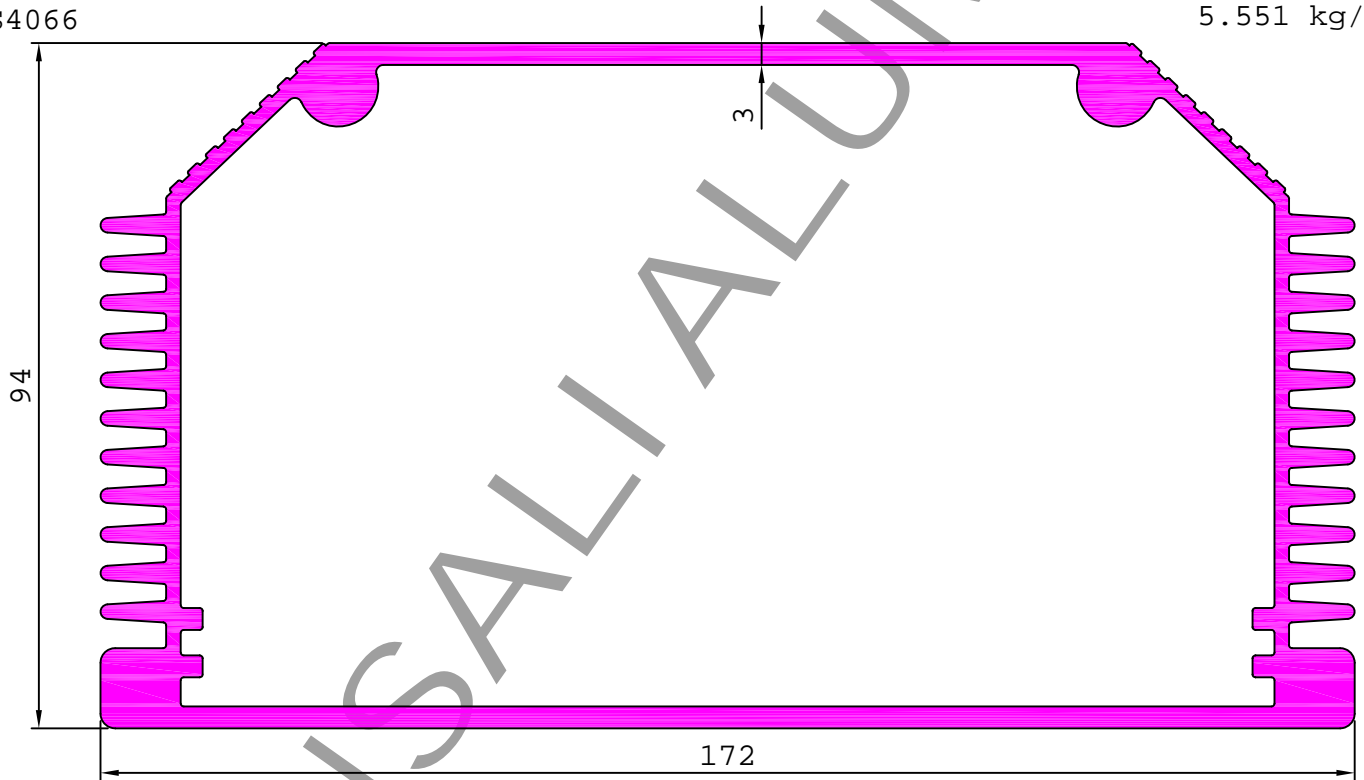

S4092

2.748 kg/m

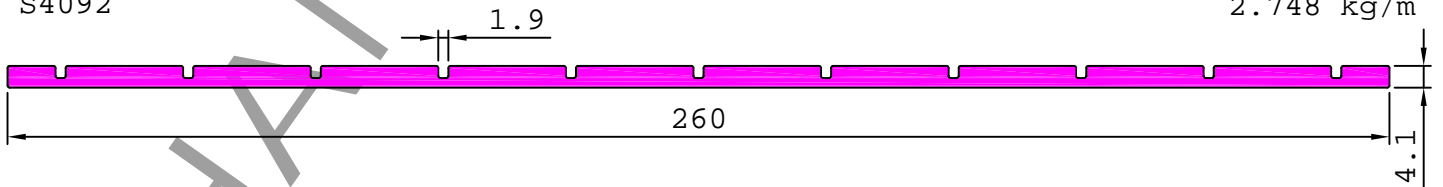

S4155

0.613 kg/m

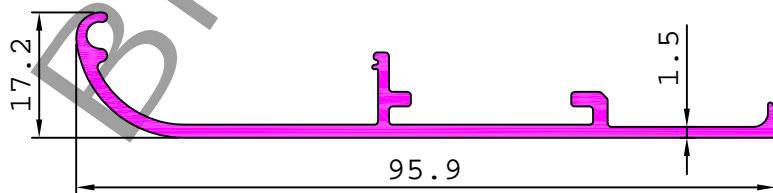

S4095

0.250 kg/m

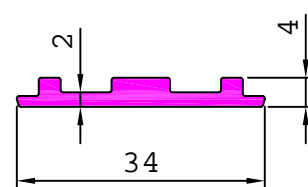

INDUSTRIAL

ELECTRICALS

S3881 5.955 kg/m

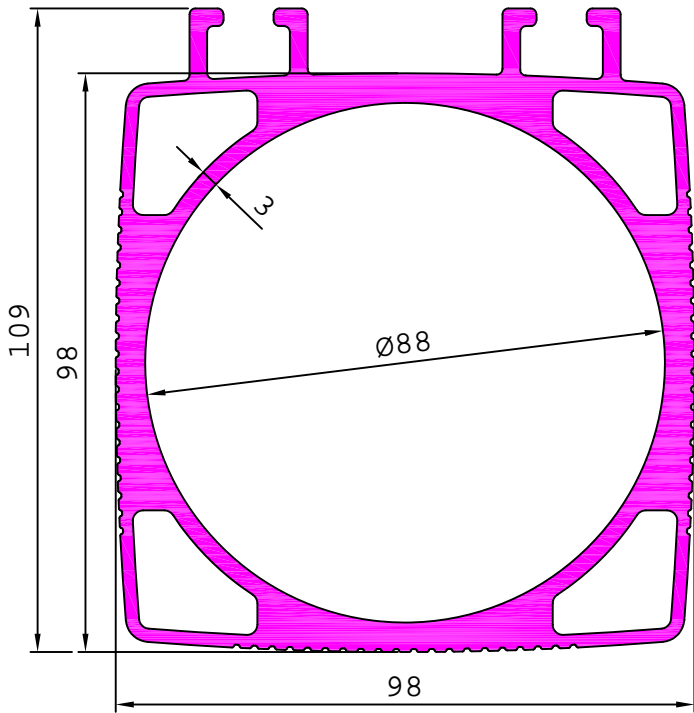

29235 0.834 kg/m

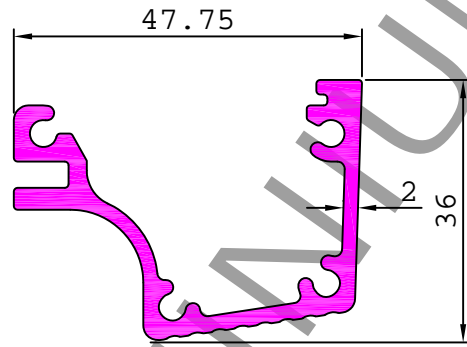

35077 0.157 kg/m

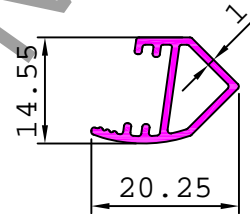

29310 1.577 kg/m

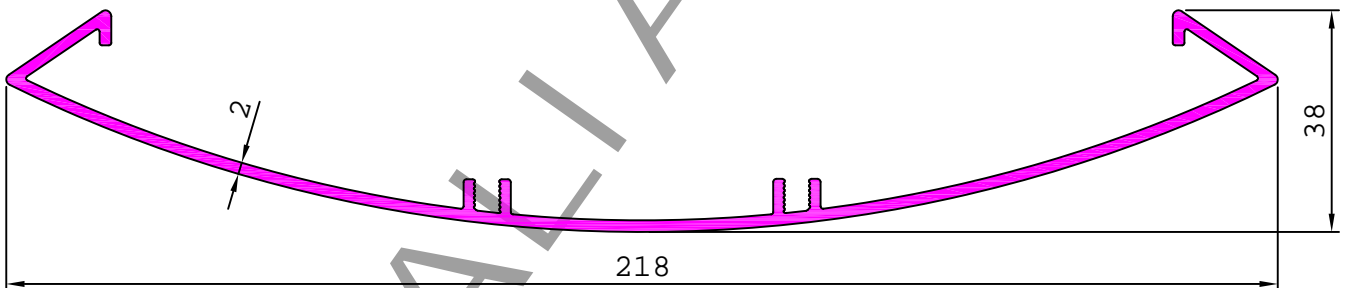

35078 0.565 kg/m

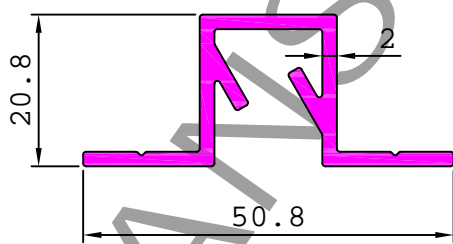

35079 0.630 kg/m

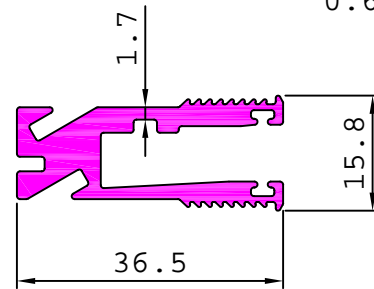

35080 0.830 kg/m

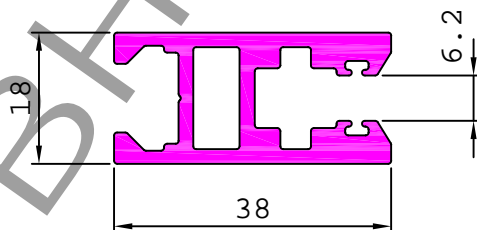

35081 0.363 kg/m

