

# INDUSTRIAL

## SOLAR POWER SECTION

26206 0.622 kg/m

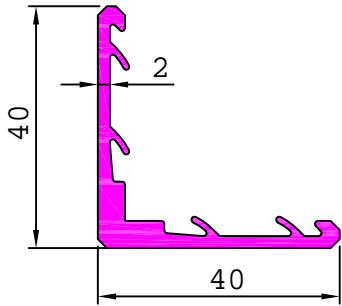

26215 0.365 kg/m

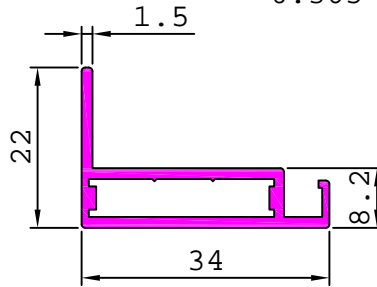

26214 0.261 kg/m

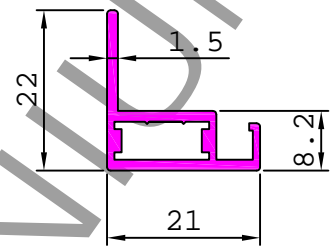

26210 0.578 kg/m

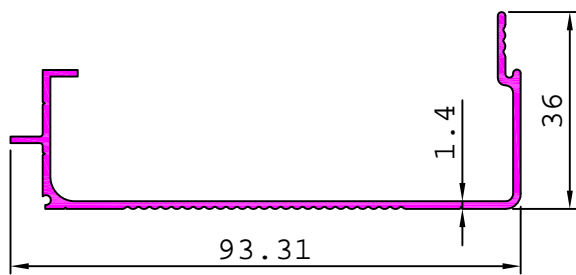

26211 0.688 kg/m

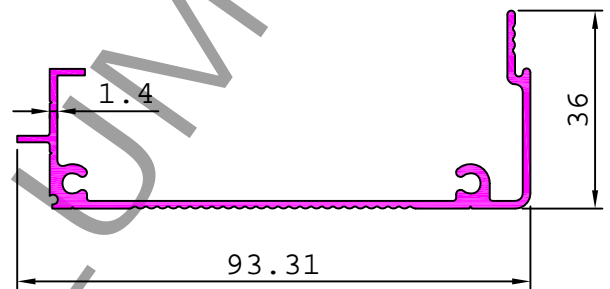

26216 0.941 kg/m

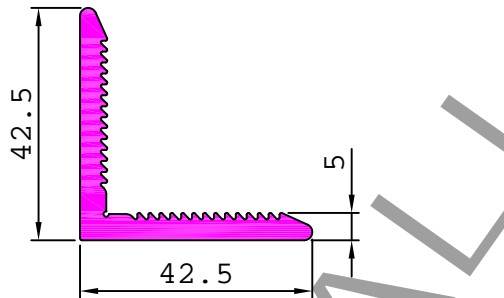

26217 0.552 kg/m

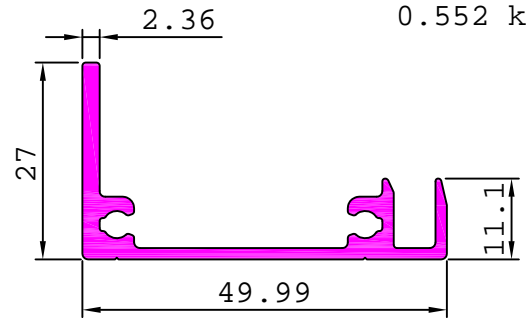

26219 0.285 kg/m

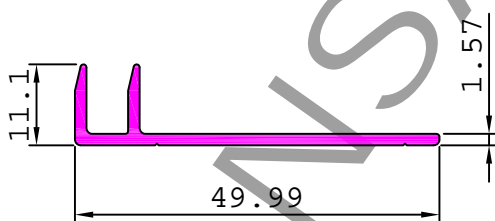

26225 0.829 kg/m

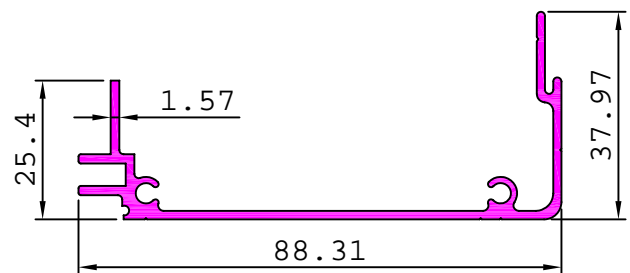

26224 0.141 kg/m

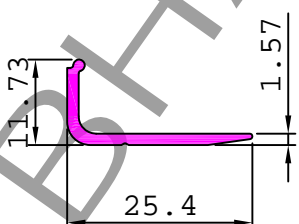

26232 0.111 kg/m

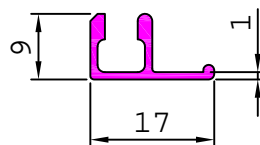

26233 0.163 kg/m

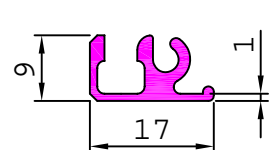

# INDUSTRIAL

## SOLAR POWER SECTION

26235 0.494 kg/m

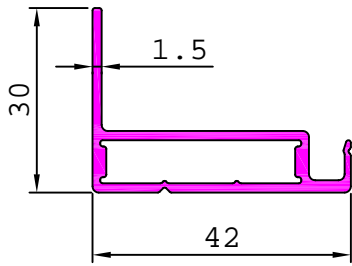

26240 0.339 kg/m

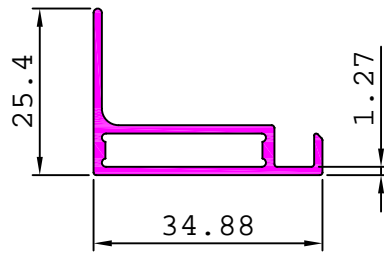

26241 0.633 kg/m

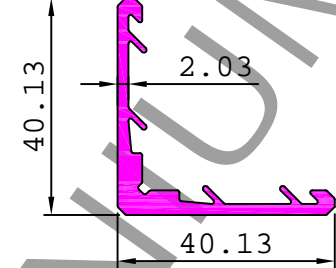

26242 0.605 kg/m

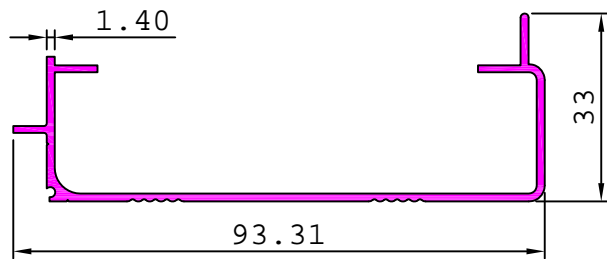

26243 0.716 kg/m

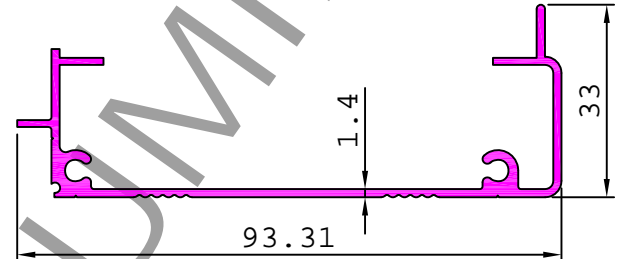

26244 0.198 kg/m

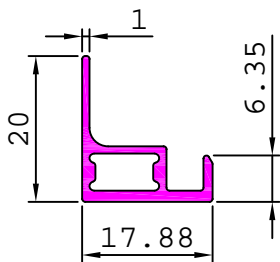

26245 0.780 kg/m

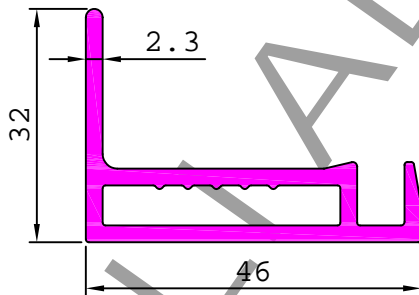

26249 0.531 kg/m

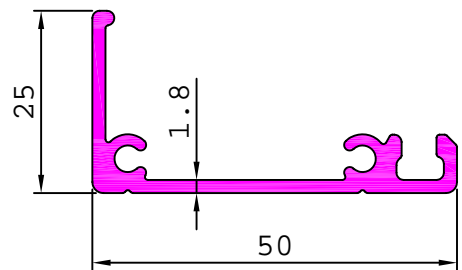

26250 0.315 kg/m

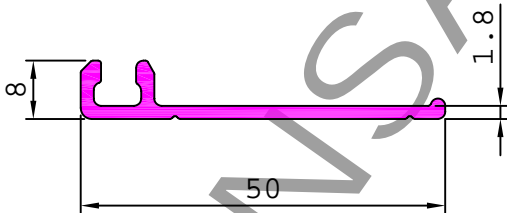

26251 0.483 kg/m

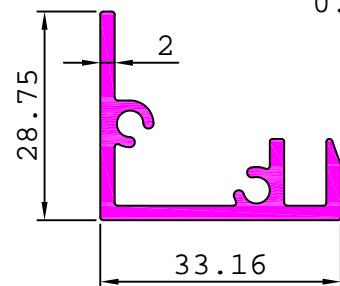

26253 0.627 kg/m

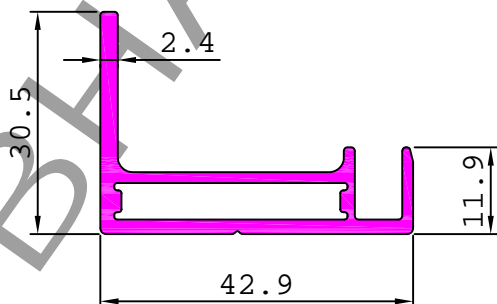

26254 0.459 kg/m

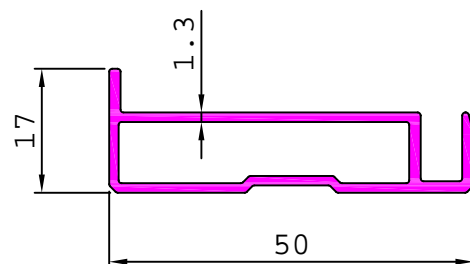

# INDUSTRIAL

## SOLAR POWER SECTION

26255 0.887 kg/m

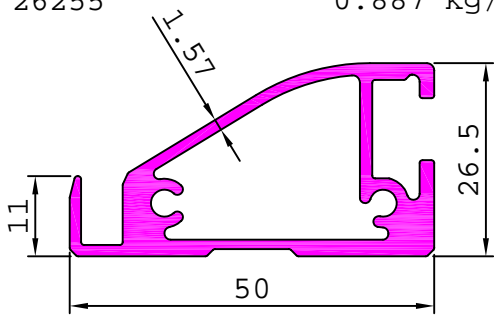

26256 0.256 kg/m

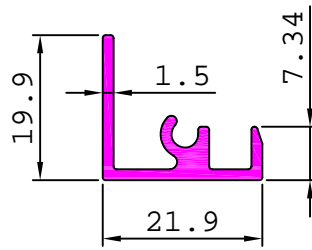

26257 0.133 kg/m

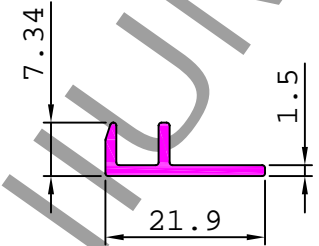

26258 0.270 kg/m

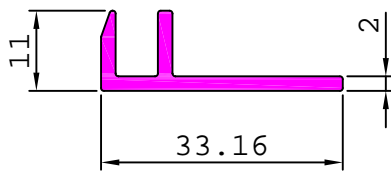

26259 0.374 kg/m

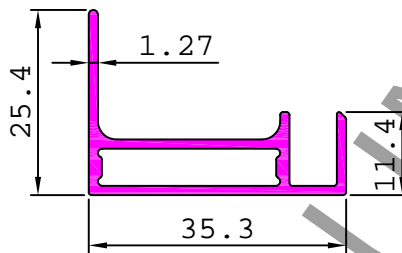

26261 0.113 kg/m

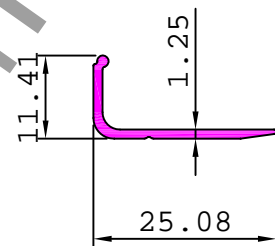

26260 0.373 kg/m

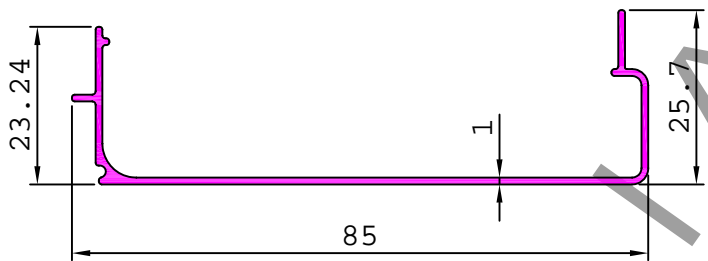

26262 0.468 kg/m

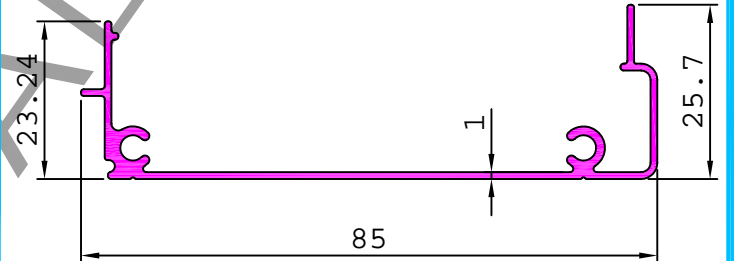

26263 0.719 kg/m

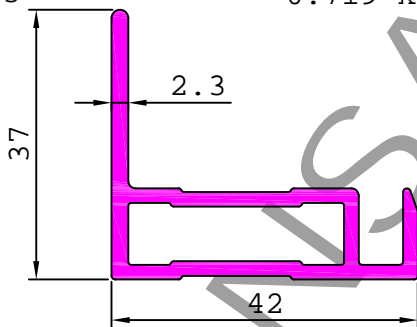

26268 0.708 kg/m

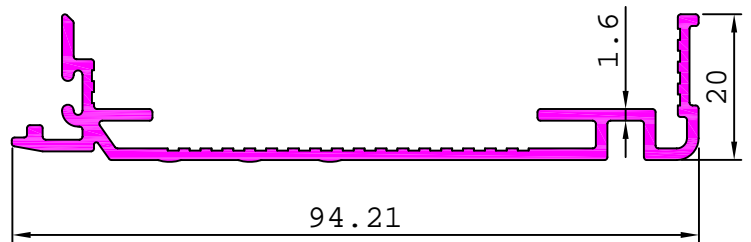

26264 0.768 kg/m

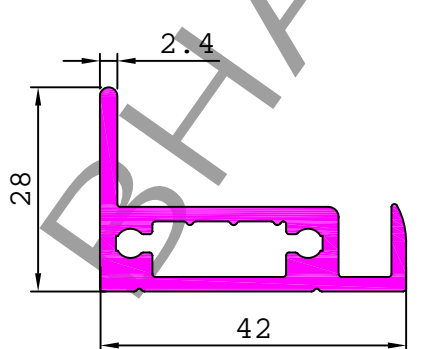

26265 0.639 kg/m

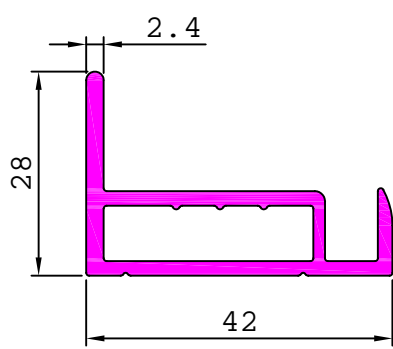

26266 0.372 kg/m

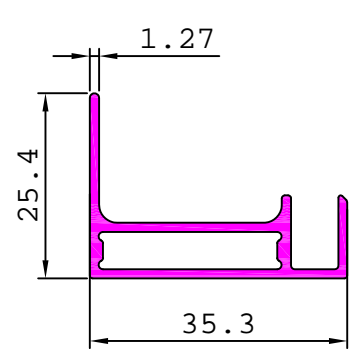

# INDUSTRIAL

## SOLAR POWER SECTION

<p>26267 0.173 kg/m</p>	<p>26269 0.631 kg/m</p>	<p>26270 0.378 kg/m</p>
<p>26271 0.471 kg/m</p>	<p>26272 0.344 kg/m</p>	
<p>26273 0.902 kg/m</p>	<p>26274 0.618 kg/m</p>	
<p>26275 0.525 kg/m</p>	<p>26276 0.680 kg/m</p>	
<p>26277 0.308 kg/m</p>	<p>26278 0.355 kg/m</p>	<p>26279 0.721 kg/m</p>

# INDUSTRIAL

## SOLAR POWER SECTION

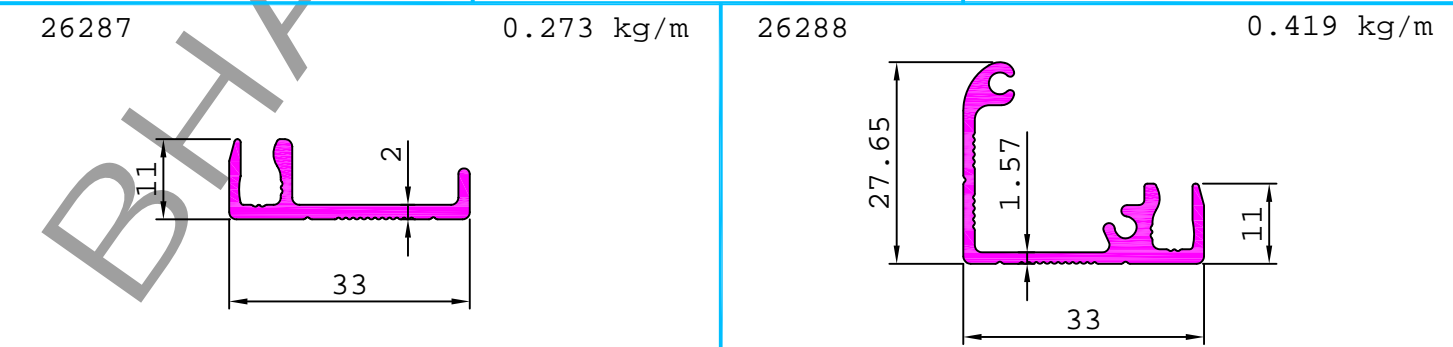
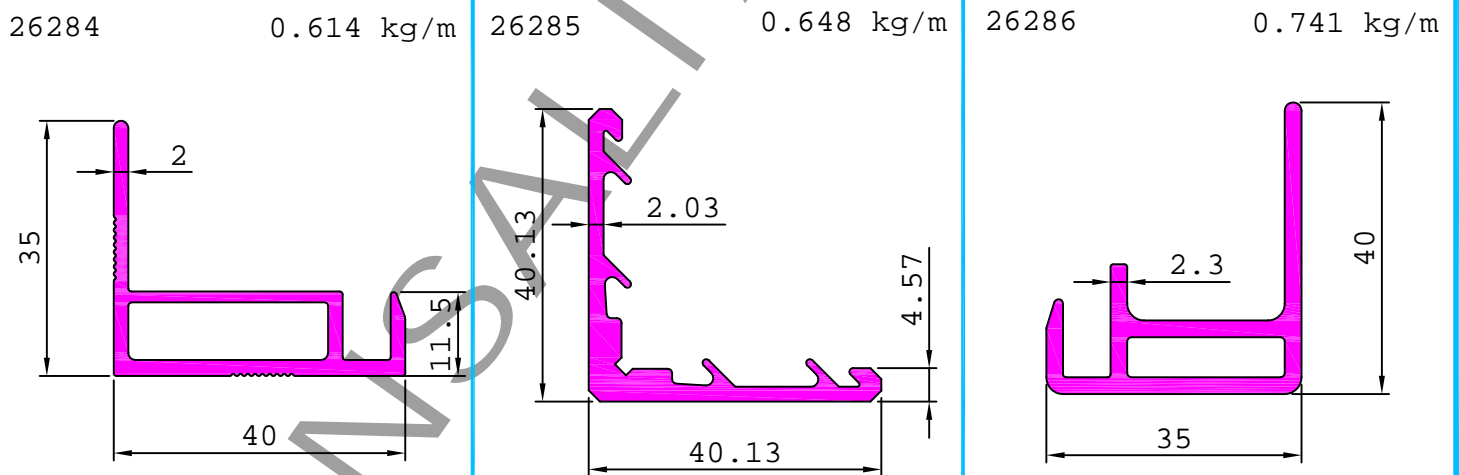
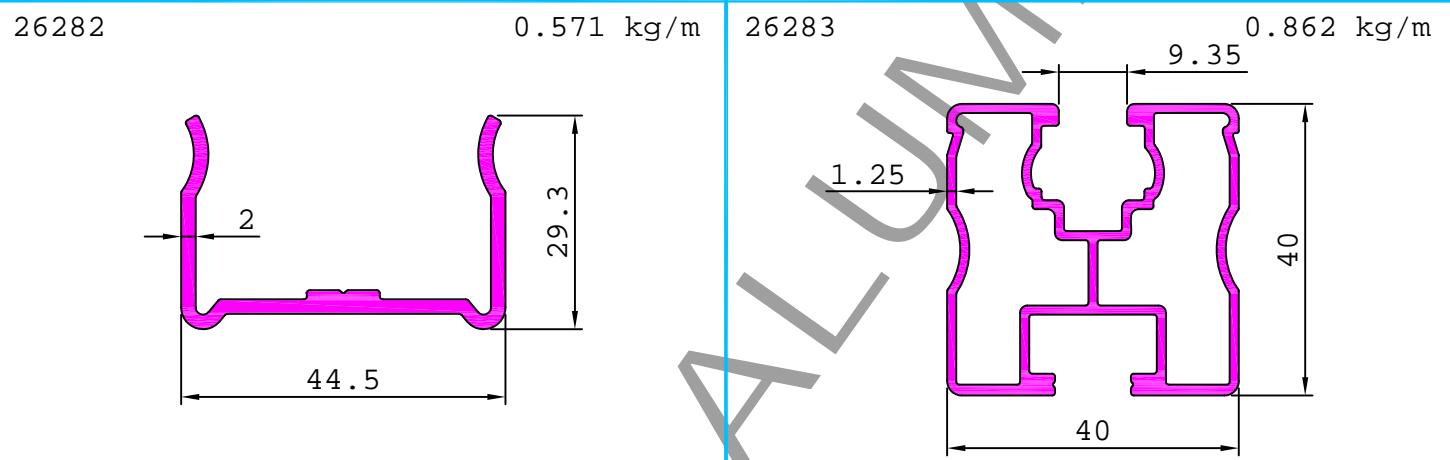
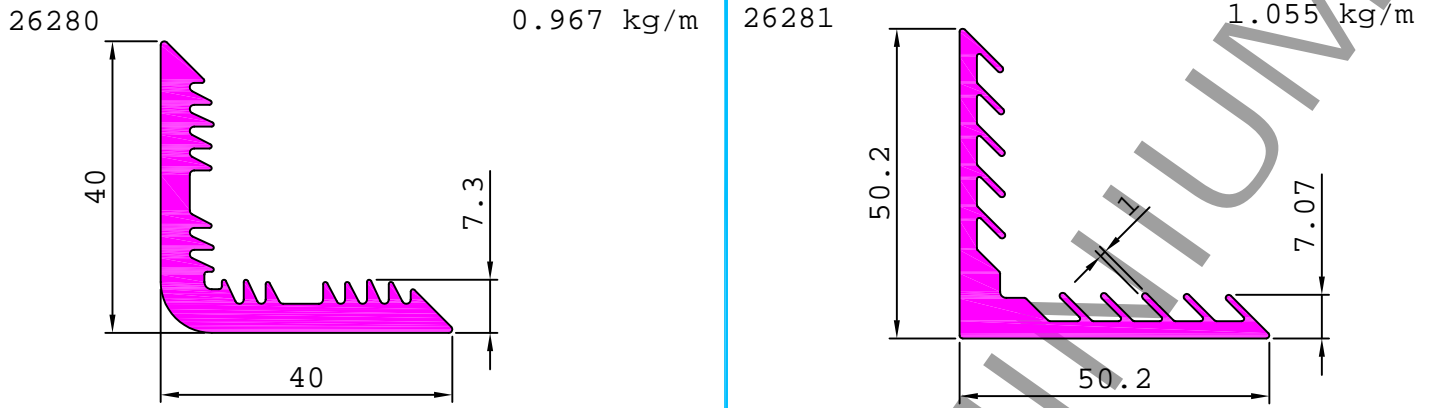

# INDUSTRIAL

## SOLAR POWER SECTION

26289 0.595 kg/m

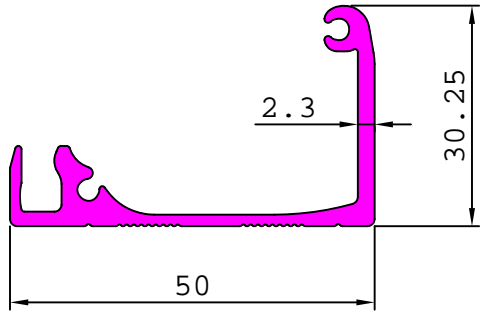

26290 0.599 kg/m

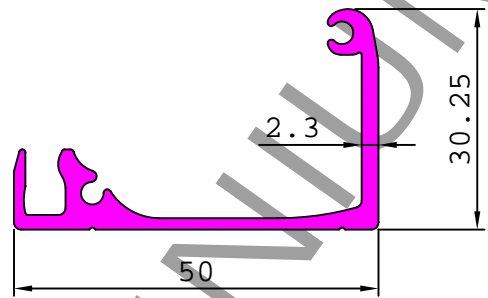

26291 0.454 kg/m

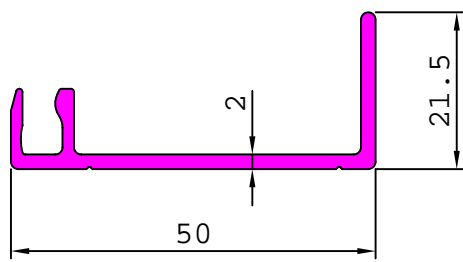

27909 1.365 kg/m

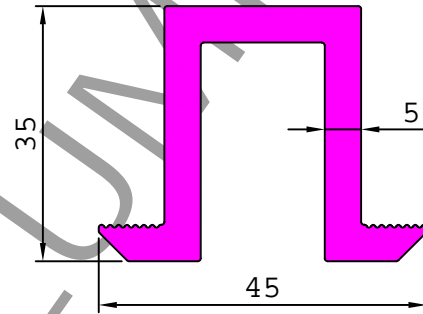

26292 1.028 kg/m

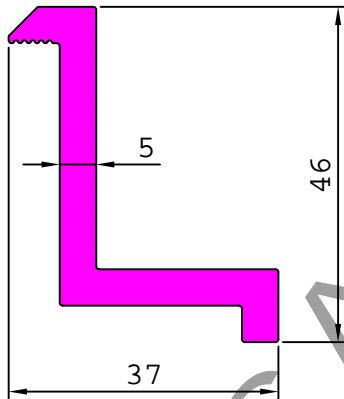

26293 0.933 kg/m

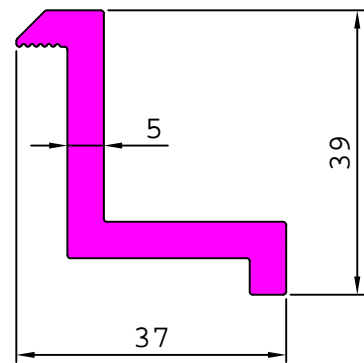

26295 0.419 kg/m

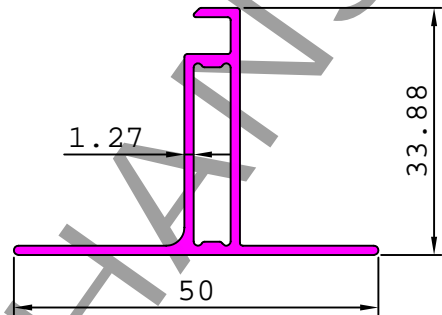

S3367 0.404 kg/m

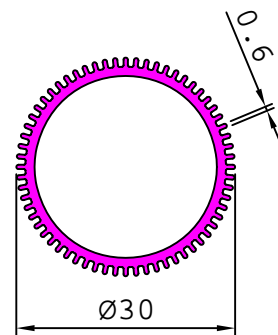

26294 0.380 kg/m

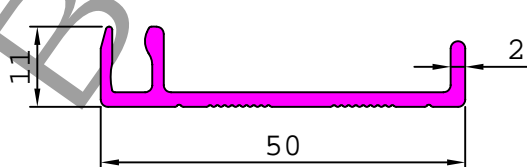

S3750 0.343 kg/m

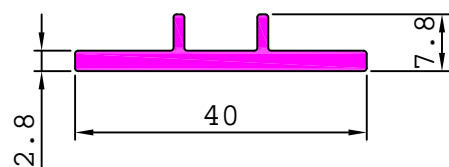

# INDUSTRIAL

## SOLAR POWER SECTION

S4048

0.642 kg/m

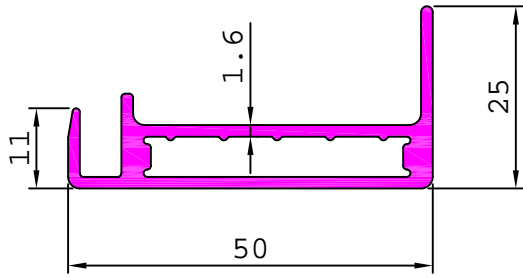

S4049

0.636 kg/m

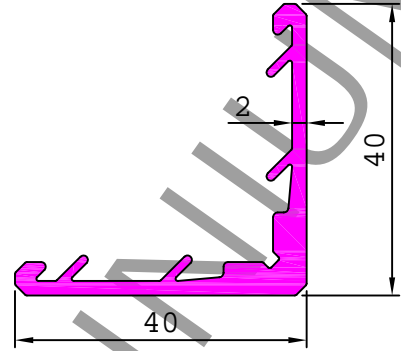

BHANSALI ALUMINIUM