

# INDUSTRIAL

## REFRIGERATION SECTION

26504

2.292 kg/m

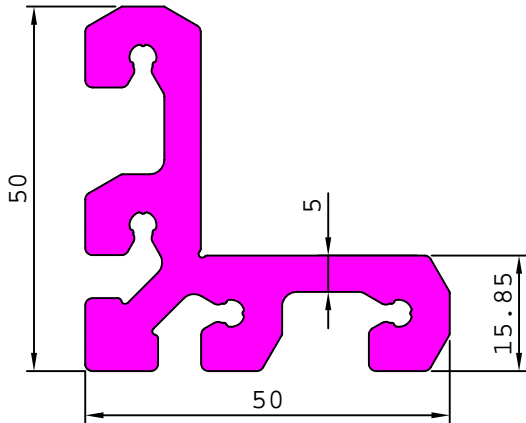

26663

3.173 kg/m

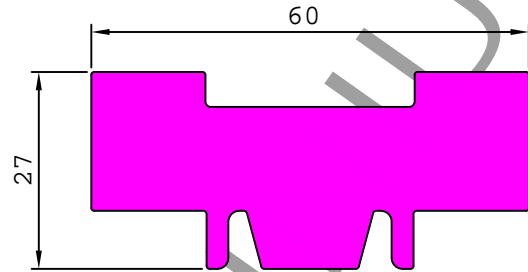

26664

2.547 kg/m

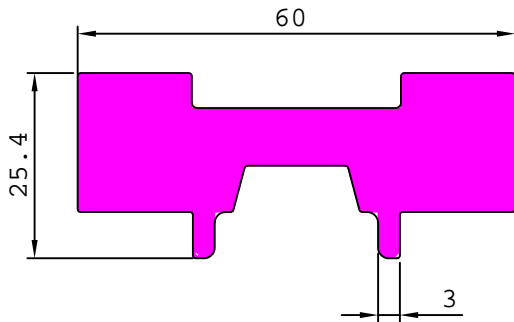

26823

1.268 kg/m

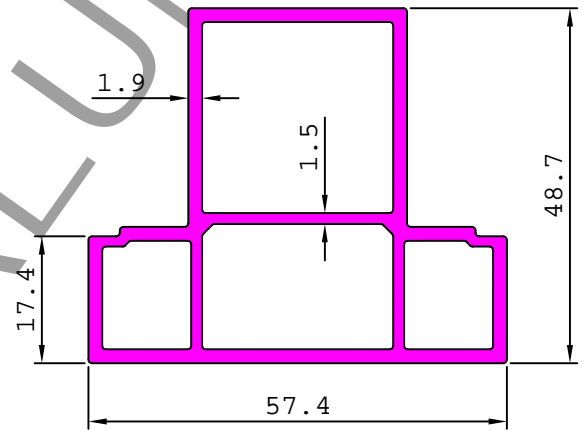

26839

0.717 kg/m

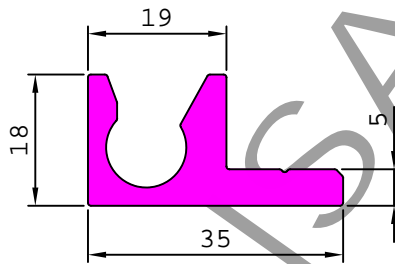

26840

0.886 kg/m

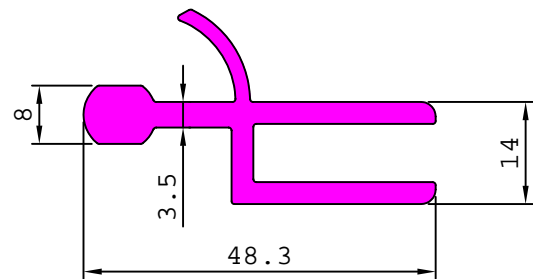

26849

0.850 kg/m

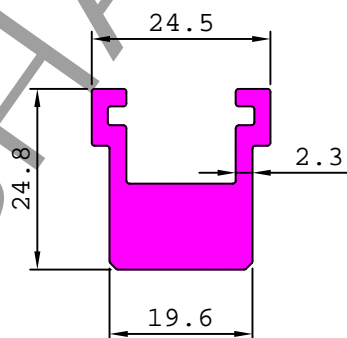

26850

1.327 kg/m

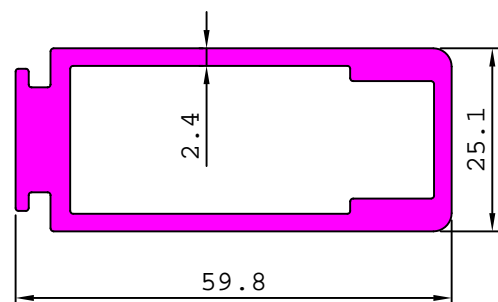

# INDUSTRIAL

## REFRIGERATION SECTION

26851 1.078 kg/m

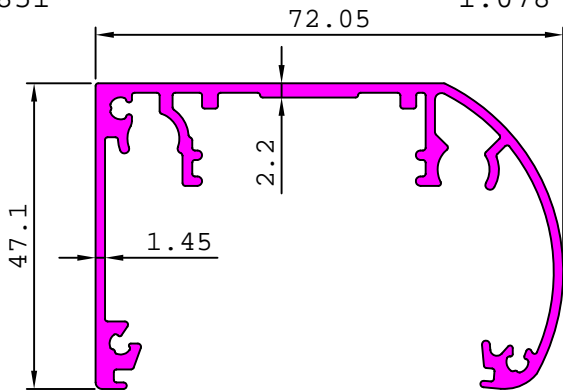

26857 0.526 kg/m

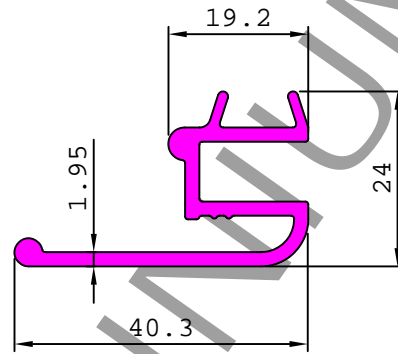

26858 0.777 kg/m

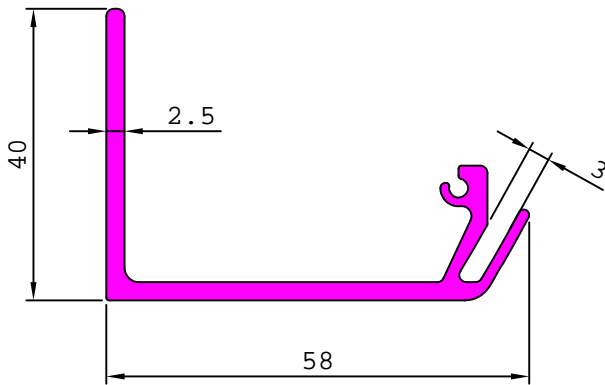

26859 1.181 kg/m

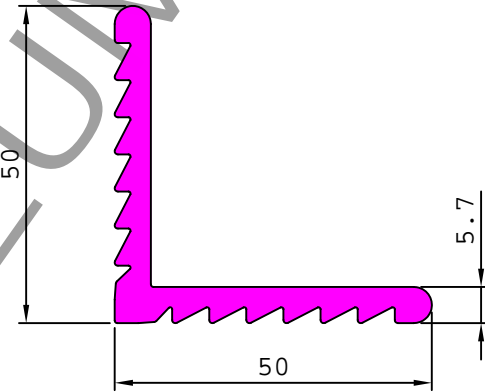

26860 0.267 kg/m

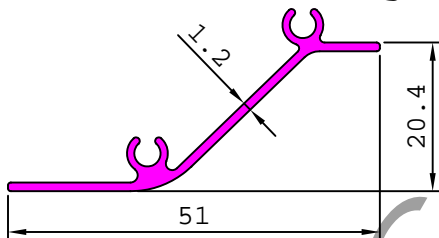

26868 0.155 kg/m

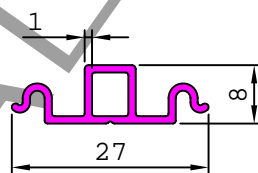

26874 0.347 kg/m

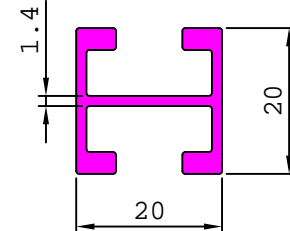

26870 1.724 kg/m

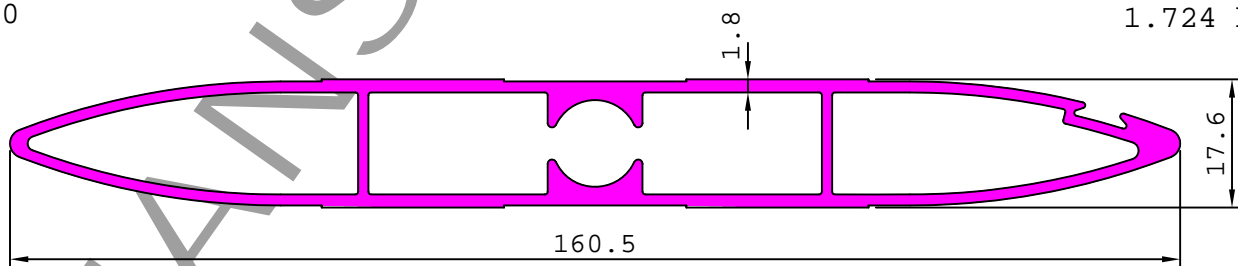

26875 0.160 kg/m

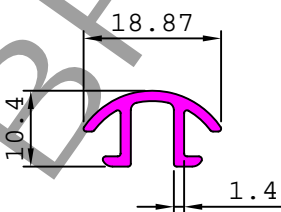

26876 1.050 kg/m

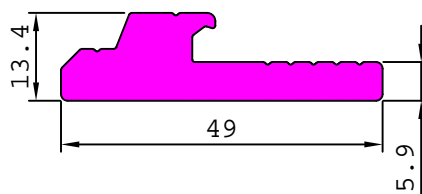

26878 0.429 kg/m

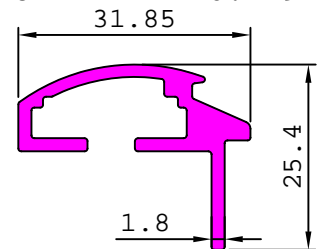

# INDUSTRIAL

## REFRIGERATION SECTION

26877

0.783 kg/m

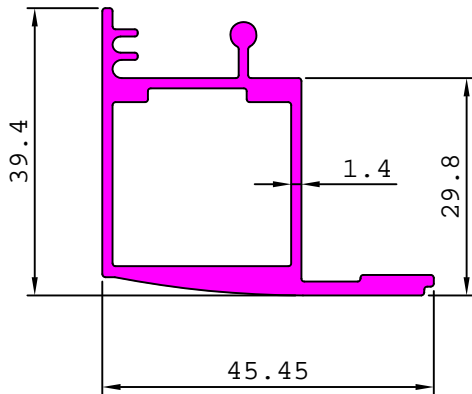

26879

0.795 kg/m

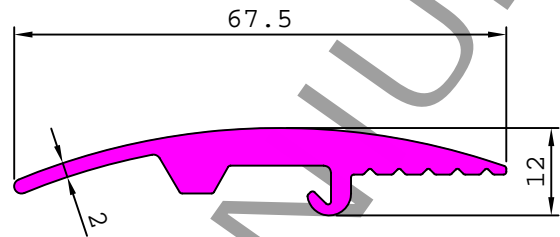

26880

0.897 kg/m

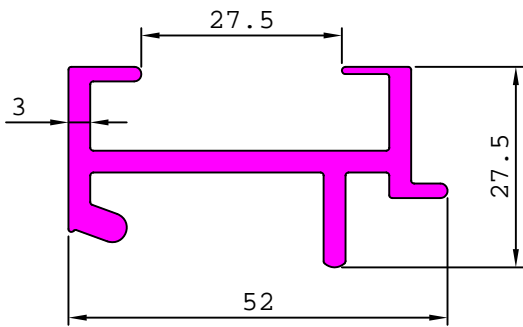

29210

0.855 kg/m

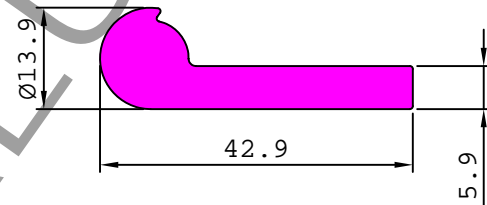

29211

0.740 kg/m

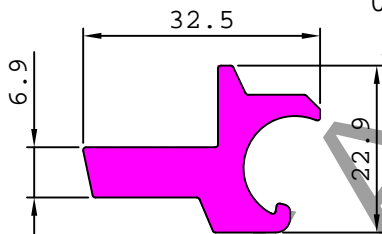

S3684

0.656 kg/m

